



F.lli CONGIUSTI

Aste, pennoni e accessori per bandiere
Piantane di delimitazione

Flagpoles and flags accessories

Queue barriers



UN PO' DI STORIA

La Congiusti s.n.c. fondata nel 1985 da Giuseppe Congiusti, è tra le prime aziende in Italia specializzate nella produzione e distribuzione della più vasta gamma di aste ed accessori metallici per bandiere, pennoni, strutture per la comunicazione visiva, articoli per esposizioni museali, stands fieristici ed eventi di ogni genere.

Le qualità organizzative, la flessibilità, le continue e innovative creazioni e il costante aggiornamento sono indice di un'esperienza che solo aziende presenti da decenni sul mercato riescono a maturare: la Congiusti snc, si è distinta per professionalità ed efficienza, mettendo sempre al primo posto qualità e precisione.

Negli ultimi vent'anni la Congiusti è cresciuta trasferendosi dalla sede di Villa Carcina alla nuova collocazione di Passirano per soddisfare le esigenze di mercato.

La nuova F.Ili Congiusti

Nel 2013 l'azienda continua il suo storico percorso con il passaggio dell'attività ai figli, che, con l'ineguagliabile consulenza del fondatore prosegue un'identità lavorativa unica e consolidata, impegnandosi nella ricerca di prodotti innovativi al fine di produrre articoli esclusivi.

L'evolversi del mercato ha creato la necessità di ampliare ulteriormente la nostra struttura produttiva ed incrementare notevolmente gli articoli presenti a catalogo: oggi la "F.Ili Congiusti" può contare su 600 prodotti di indiscussa qualità superiore sempre in pronta consegna, collaudati singolarmente prima della spedizione.

The History

The Congiusti s.n.c. was founded in 1985 by Giuseppe Congiusti. It was the first company in Italy specialized in the production and distribution of the widest range of rods and metal accessories for flags, pennants, facilities for visual communication, articles for museum exhibitions, exhibition stands and events of all kind. The organizational skills, flexibility, continuous and innovative creations and constant updates are index of an experience that only companies which were operating on the market for decades managed to mature. The Congiusti snc, has distinguished itself for its professionalism and efficiency, always putting on the first place quality and precision. During the last two decades Congiusti S.n.c. has grown and to meet the need of the market moved from the old location in Villa Carcina (BS) to the new location in Passirano (BS).

The present of F.Ili Congiusti In 2013, the company continues its historic journey with the passage of the activity to the sons, who, with the support of the founder continue their unique and well working identity, engaging themselves in the research of innovative products in order to produce exclusive items. The evolution of the market has created the need to expand further our production structure and increase significantly the items in the catalogue. At present, Congiusti company can count on 600 products of undisputed quality, ready for delivery and individually tested before shipping.

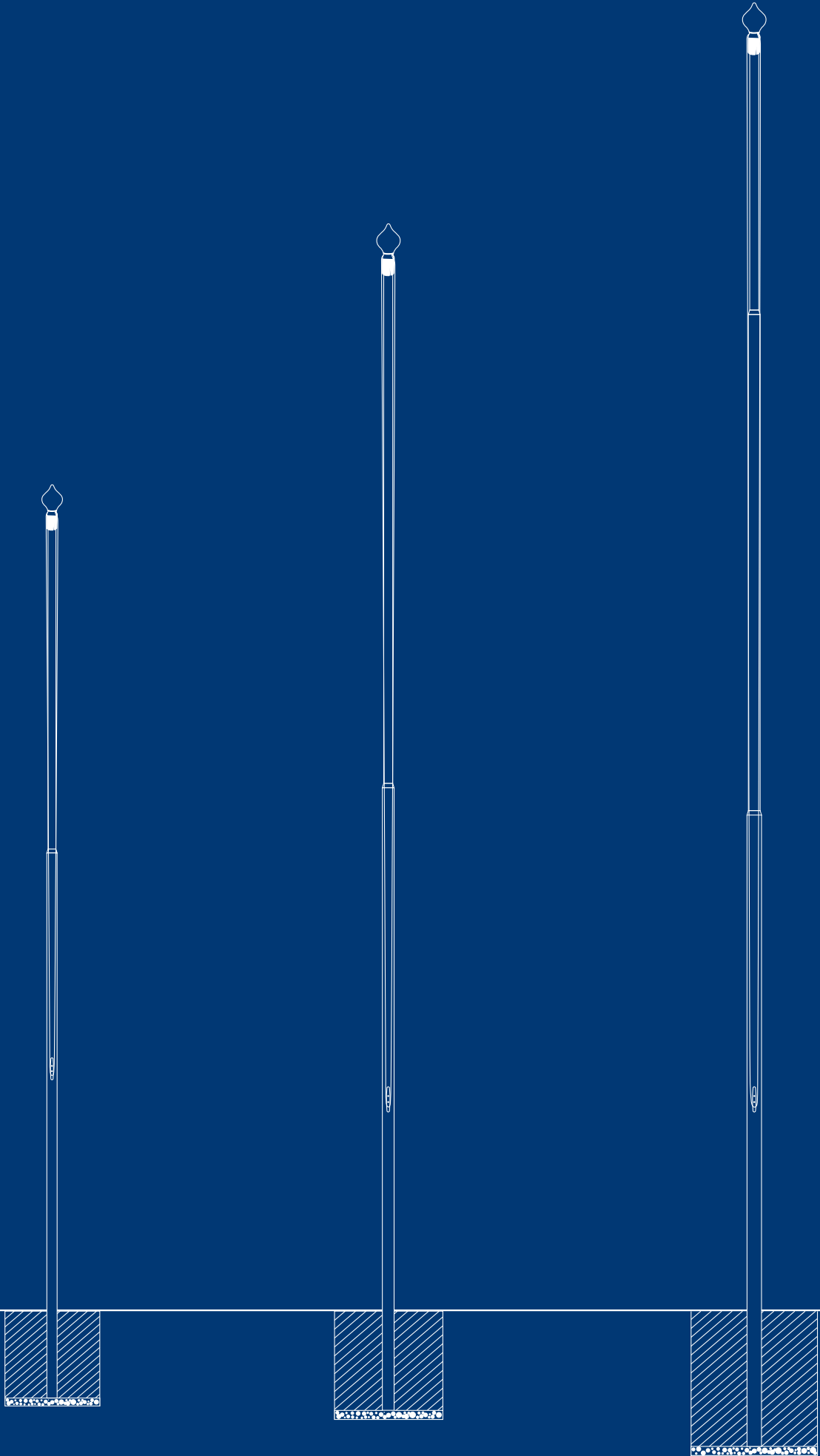

INDICE

Set economici da sala	pag. 05
Aste alluminio anodizzato Ø 22	pag. 06
Aste alluminio anodizzato oro Ø 22	pag. 08
Aste alluminio Ø 25 mm per esterno ed accessori	pag. 10
Aste alluminio Ø 32 mm per esterno ed accessori	pag. 12
Aste alluminio Ø 50 mm per esterno ed accessori	pag. 15
Aste per bandiera cromate economiche	pag. 18
Aste ottone cromato Ø 22 mm	pag. 19
Aste ottone dorato Ø 22 mm	pag. 20
Aste ottone cromato Ø 32 mm	pag. 21
Aste ottone lux Ø 32 mm	pag. 22
Aste velluto personalizzate	pag. 23
Aste velluto militari Esercito e Marina Militare	pag. 24
Basette per bandierine da tavolo	pag. 25
Basi da interno economiche	pag. 30
Basi da interno ottone cromato	pag. 34
Basi da interno ottone lucido	pag. 37
Basi per esterno	pag. 40
Borse e cinturoni	pag. 43
Traverse per labari e gonfaloni silver	pag. 44
Traverse dorate per labari e gonfaloni	pag. 46
Pomoli per aste e terminali per traverse in ottone	pag. 47
Lance ed emblemi in ottone	pag. 50
Linea ferro battuto	pag. 55
Linea acciaio inox	pag. 57
Supporti da parete e accessori per esterno	pag. 60
Pennoni e accessori	pag. 64
Piantane, cordoni e accessori	pag. 69
Piantane tendex e accessori	pag. 73
Articoli per gagliardetti	pag. 75
Articoli per veicoli	pag. 76
Accessori e ricambi	pag. 78





SET ECONOMICI DA SALA

ECONOMICAL HALL SET

Base Ø 280 mm, Kg 4,5
Asta in ferro cromato cm 200
Pomolo/lancia in ottone

Ø 280 mm, Kg 4,5 stand
cm 200 chrome iron flagpole
Brass ball/spearhead



	Base cromata + Asta + Pomolo <i>Chromed Stand + Flagpole + Ball</i>	Art. BAP/1-C
---	--	---------------------

	Base cromata + Asta + Lancia <i>Chromed Stand + Flagpole + Spearhead</i>	Art. BAL/1-C
--	---	---------------------



	Base cromata + 2 Aste + 2 Pomoli <i>Chromed Stand + 2 Flagpoles + 2 Balls</i>	Art. BAP/2-C
---	--	---------------------

	Base cromata + 2 Aste + 2 Lance <i>Chromed Stand + 2 Flagpoles + 2 Spearheads</i>	Art. BAL/2-C
---	--	---------------------



	Base cromata + 3 Aste + 3 Pomoli <i>Chromed Stand + 3 Flagpoles + 3 Balls</i>	Art. BAP/3-C
---	--	---------------------

	Base cromata + 3 Aste + 3 Lance <i>Chromed Stand + 3 Flagpoles + 3 Spearheads</i>	Art. BAL/3-C
---	--	---------------------

ASTE ALLUMINIO ANODIZZATO Ø 22 mm

Ø 22 mm ANODIZED ALUMINIUM FLAGPOLES

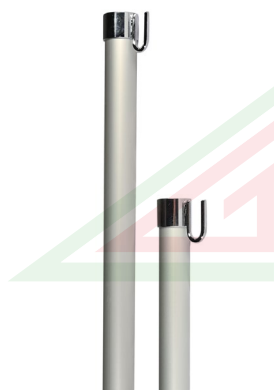

cm 150 con gancio
cm 150 w/hook

Art. 0199

cm 200 con gancio
cm 200 w/hook

Art. 0200



Gancio optional per asta Ø 22 mm
Ø 22 mm flagpole optional hook

Art. 0553

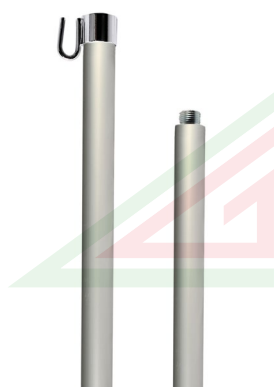

cm 150, 2 pezzi con gancio
cm 150, 2 sections w/hook

Art. 0094/AL

cm 200, 2 pezzi con gancio
cm 200, 2 sections w/hook

Art. 0078/AL

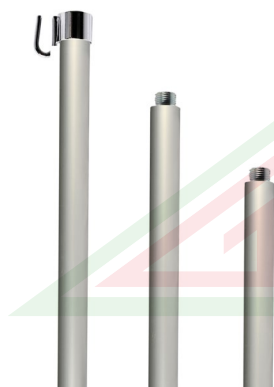

cm 180, 3 pezzi con gancio
cm 180, 3 sections w/hook

Art. 0074/AL

cm 225, 3 pezzi con gancio
cm 225, 3 sections w/hook

Art. 0076/AL

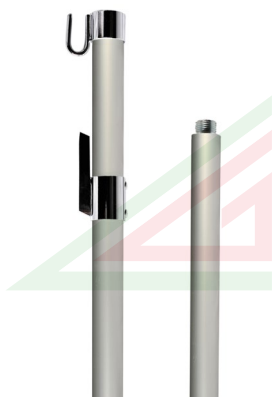

cm 150, 2 pezzi per gonfalone
cm 150, 2 sections for standard

Art. 0094/G/AL

cm 200, 2 pezzi per gonfalone
cm 200, 2 sections for standard

Art. 0078/G/AL

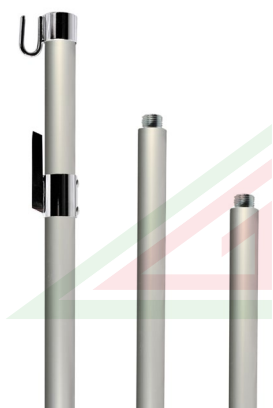

cm 180, 3 pezzi per gonfalone
cm 180, 3 sections for standard

Art. 0074/G/AL

cm 225, 3 pezzi per gonfalone
cm 225, 3 sections for standard

Art. 0076/G/AL

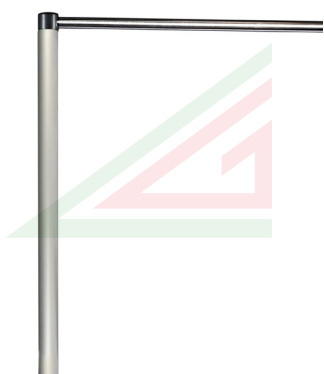

cm 200 con braccio girevole
cm 200 for banner

Art. 0220/AL

cm 250 con braccio girevole
cm 250 for banner

Art. 0221/AL

ASTE ALLUMINIO ANODIZZATO Ø 22 mm
Ø 22 mm ANODIZED ALUMINIUM FLAGPOLES

ASTE ALLUMINIO ANODIZZATO ORO Ø 22 mm

Ø 22 mm GOLDEN ANODIZED ALUMINIUM FLAGPOLES



cm 150, 2 pezzi con gancio
cm 150, 2 sections w/wook

Art. 0094/AL/LUX

cm 200, 2 pezzi con gancio
cm 200, 2 sections w/hook

Art. 0078/AL/LUX

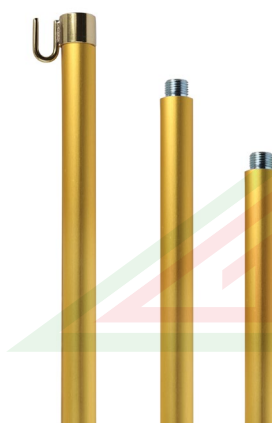

cm 180, 3 pezzi con gancio
cm 180, 3 sections w/hook

Art. 0074/AL/LUX

cm 225, 3 pezzi con gancio
cm 225, 3 sections w/hook

Art. 0076/AL/LUX



cm150, 2 pezzi per gonfalone
cm 150, 2 sections for standard

Art. 0094/G/AL/LUX

cm200, 2 pezzi per gonfalone
cm 200, 2 sections for standard

Art. 0078/G/AL/LUX

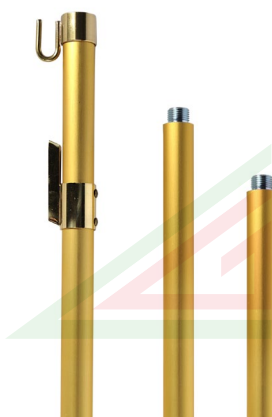

cm 180, 3 pezzi per gonfalone
cm 180, 3 sections for standard

Art. 0078/G/AL/LUX

cm 225, 3 pezzi per gonfalone
cm 225, 3 sections for standard

Art. 0076/G/AL/LUX

ASTE ALLUMINIO ANODIZZATO ORO Ø 22 mm
Ø 22 mm GOLDEN ANODIZED ALUMINIUM FLAGPOLES

ASTE ALLUMINIO Ø 25 mm per esterno ed accessori

OUTDOOR Ø 25 mm ALUMINIUM FLAGPOLES AND ACCESSORIES

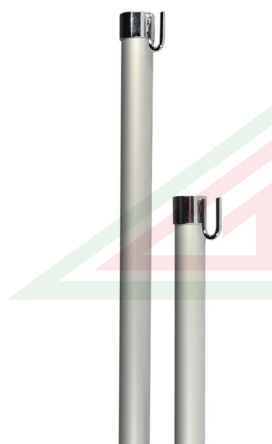

cm 200 con gancio
cm 200 w/hook

Art. 0399/25

cm 250 con gancio
cm 250 w/hook

Art. 0400/25



Gancio optional per asta Ø 25 mm
Ø 25 mm flagpole optional hook

Art. 0554

Struttura a goccia Drop Frame



Struttura a vela Sail Frame

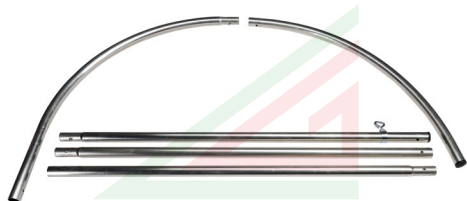

Misure strutture a goccia Drop frame dimensions:

90X220 cm
90X250 cm
90X300 cm
90X400 cm

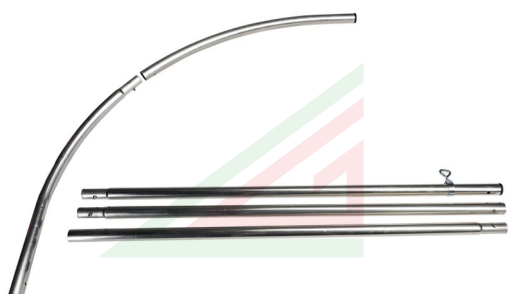

Misure strutture a vela Sail frame dimensions:

70X230 cm
70X300 cm
90X320 cm
90X415 cm
90X510 cm

ASTE ALLUMINIO Ø 25 mm per esterno ed accessori
OUTDOOR Ø 25 mm ALUMINIUM FLAGPOLES AND ACCESSORIES

ASTE IN ALLUMINIO Ø 32 mm per esterno ed accessori

OUTDOOR Ø 32 mm ANODIZED ALUMINIUM FLAGPOLES



Con ganci - w/hooks

cm 200	Art. 0399
cm 250	Art. 0400
cm 300	Art. 0450
cm 350	Art. 0455

Con carrucola - w/pulley

cm 250	Art. 0401
cm 300	Art. 0451
cm 350	Art. 0456



2 pezzi con ganci - 2 sections w/hooks

cm 250	Art. 0448
cm 300	Art. 0452
cm 350	Art. 0457

2 pezzi con carrucola - 2 sections w/pulley

cm 250	Art. 0449
cm 300	Art. 0453
cm 350	Art. 0458



Con braccio girevole - for banner

cm 200	Art. 0402
cm 250	Art. 0403
cm 300	Art. 0404
cm 350	Art. 0405

Braccio girevole per aste Ø 32 mm
Revolving arm for Ø 32 mm flagpoles

Art. 0502

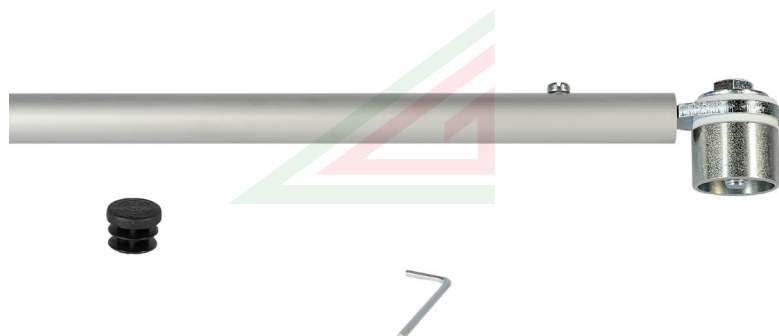

BANDIERA SEMPRE TESA E OSCILLANTE

Sistema brevettato anti arrotolamento per
aste Ø 32 mm
Patented Anti-Roll system for Ø 32 mm flagpole

Art. 0504



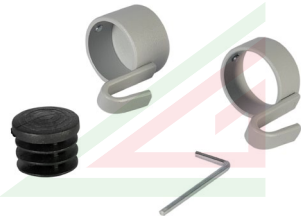

Ganci per asta Ø 32 mm
Hooks for Ø 32 mm flagpole

Art. 0361



Carrucola per asta Ø 32 mm
Pulley for Ø 32mm flagpole

Art. 0362

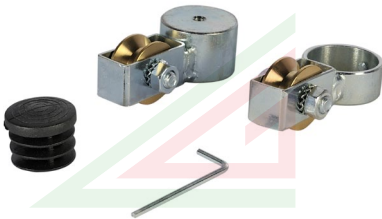

Doppie carrucole per aste Ø 32 mm
Dual pulley for Ø 32 mm flagpole

Art. 0362/A



Corda con moschettone per aste Ø 32 mm
Rope with snap-hook for Ø 32 mm flagpoles

Art. 0363

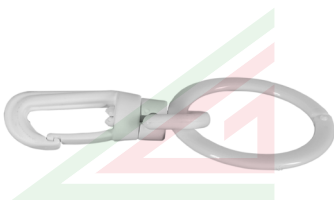

Anello con moschettone per aste Ø 32 mm
Ring with snap-hook for Ø 32 mm flagpole

Art. 0368/32

ASTE IN ALLUMINIO Ø 50 mm per esterno ed accessori

Ø 50 mm ANODIZED ALUMINIUM FLAGPOLES AND ACCESSORIES

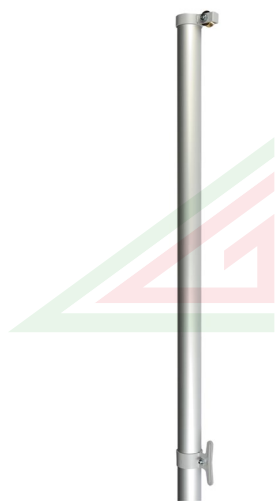

cm 350 Ø 50 mm con carrucola
Ø 50 mm, cm 350 w/pulley

Art. 0460



Ø 50 mm, 2 pezzi con carrucola
Ø 50 mm, 2 sections, w/pulley

cm 400

Art. 0470

cm 450

Art. 0480

cm 500

Art. 0500

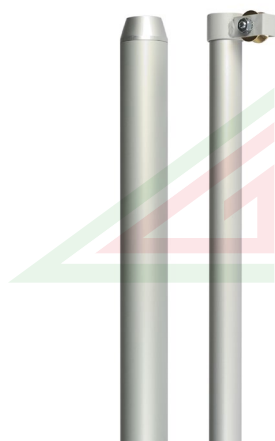

cm 400, 2 pezzi Ø 50-32 mm con carrucola
cm 400, 2 sections Ø 50-32 mm w/pulley

Art. 0489

cm 500, 2 pezzi Ø 50-32 mm con carrucola
cm 500, 2 sections Ø 50-32 mm w/pulley

Art. 0501

ASTE IN ALLUMINIO Ø 50 mm per esterno ed accessori
Ø 50 mm ANODIZED ALUMINIUM FLAGPOLES AND ACCESSORIES

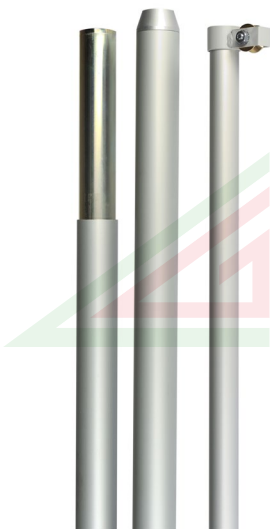

cm 600, 3 pezzi Ø 50-50-32 mm
con carrucola
cm 600, 3 sections Ø 50-50-32 mm w/pulley

Art. 0589



cm 400, 2 pezzi Ø 50-32 mm
con braccio girevole
cm 400, 2 sections Ø 50-32 mm for banner

Art. 0490

cm 500, 2 pezzi Ø 50-32 mm
con braccio girevole
cm 500, 2 sections Ø 50-32 mm for banner

Art. 0503

cm 600, 3 pezzi Ø 50-50-32 mm
con braccio girevole
cm 600, 3 sections Ø 50-50-32 mm for banner

Art. 0590



Set carrucola e galloccia per aste Ø 50 mm **Art. 0365**
Pulley and cleat set for Ø 50 mm flagpoles

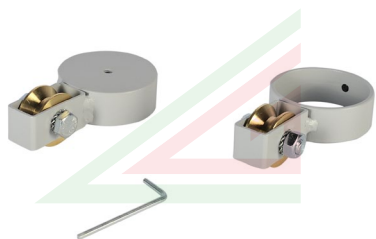

Doppie carrucole per aste Ø 50 mm **Art. 0365/50**
Dual pulley for Ø 50 mm flagpoles



Cerniera per aste Ø 50 mm **Art. 0369**
Ø 50 mm flagpoles hinge

ASTE PER BANDIERA CROMATE ECONOMICHE

ECONOMICAL CHROME FLAGPOLES

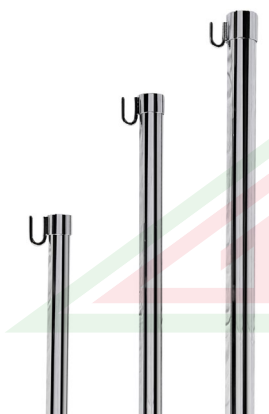

cm 200 Ø 22 mm

Art. 0201

cm 220 Ø 25mm

Art. 0203

cm 250/300, Ø 32 mm

Art. 0205



Ø 22 mm, 2 pezzi

Ø 22 mm, 2 sections

cm 150

Art. 0094/FE

cm 180

Art. 0075/FE

cm 200

Art. 0202



Ø 22 mm, 3 pezzi

Ø 22 mm, 3 sections

cm 180

Art. 0074/FE

cm 225

Art. 0076/FE

cm 250

Art. 0096/FE

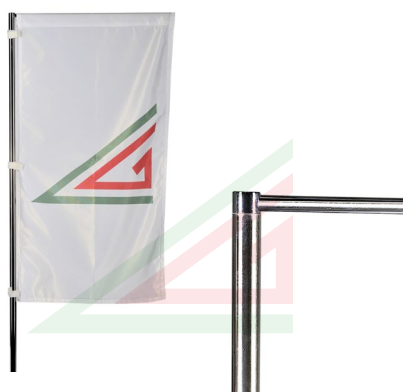

cm 200 Ø 22 mm braccio fisso

Art. 0220/FE

cm 200 Ø 22 mm w/stable arm

cm 250 Ø 22 mm braccio fisso

Art. 0221/FE

cm 250 Ø 22 mm w/stable arm

cm 300 Ø 22 mm braccio fisso

Art. 0222/FE

cm 300 Ø 22 mm w/stable arm

ASTE IN OTTONE CROMATO Ø 22 mm

Ø 22 mm CHROME BRASS POLES

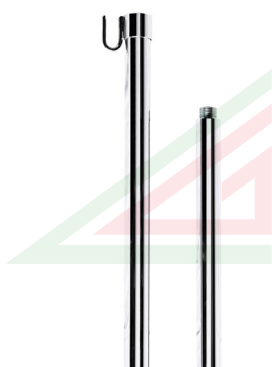

2 pezzi per bandiera
2 sections for flag

cm 150
cm 186
cm 200
cm 210

Art. 0094
Art. 0075
Art. 0078
Art. 0095

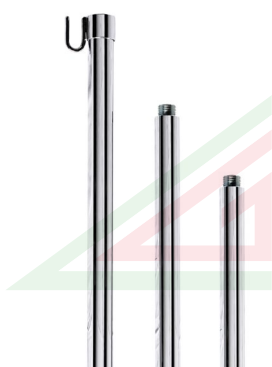

3 pezzi per bandiera
3 sections for flag

cm 180
cm 225
cm 250
cm 280
cm 300

Art. 0074
Art. 0076
Art. 0096
Art. 0077
Art. 0097

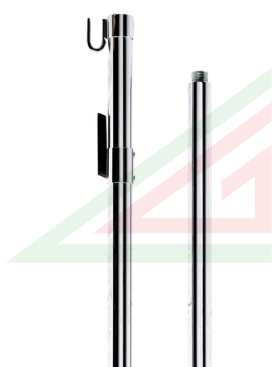

2 pezzi per gonfalone
2 sections for standard

cm 150
cm 186
cm 200
cm 210

Art. 0094/G
Art. 0075/G
Art. 0078/G
Art. 0095/G

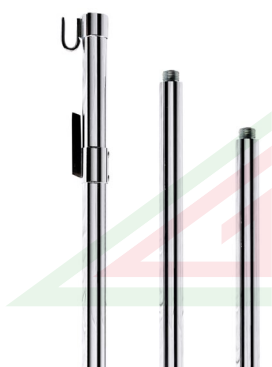

3 pezzi per gonfalone
3 sections for standard

cm 180
cm 225
cm 250
cm 280

Art. 0074/G
Art. 0076/G
Art. 0096/G
Art. 0077/G

ASTE IN OTTONE CROMATO Ø 22 mm
Ø 22 mm CHROME BRASS POLES

ASTE IN OTTONE DORATO Ø 22 mm

Ø 22 mm GOLDEN BRASS POLES



2 pezzi per bandiera
2 sections for flag

cm 150
cm 200
cm 210

Art. 0094/LUX
Art. 0078/LUX
Art. 0095/LUX



3 pezzi per bandiera
3 sections for flag

cm 180
cm 225
cm 250

Art. 0074/LUX
Art. 0076/LUX
Art. 0096/LUX



2 pezzi per gonfalone
2 sections for standard

cm 150
cm 200
cm 210

Art. 0094/G/LUX
Art. 0078/G/LUX
Art. 0095/G/LUX



3 pezzi per gonfalone
3 sections for standard

cm 180
cm 225
cm 250

Art. 0074/G/LUX
Art. 0076/G/LUX
Art. 0096/G/LUX

ASTE IN OTTONE CROMATO Ø 32 mm

Ø 32 mm CHROME BRASS POLES



2 pezzi per bandiera
2 sections for flag

cm 200
cm 240

Art. 0130
Art. 0043



3 pezzi per bandiera
3 sections for flag

cm 250
cm 280
cm 300

Art. 0040
Art. 0132
Art. 0045

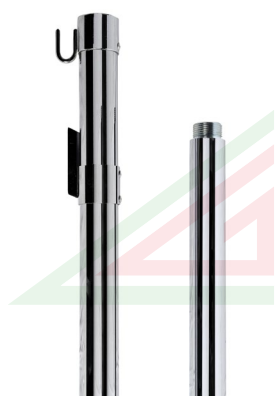

2 pezzi per gonfalone
2 sections for standard

cm 200
cm 240

Art. 0130/G
Art. 0043/G



3 pezzi per gonfalone
3 sections for standard

cm 250
cm 280
cm 300

Art. 0040/G
Art. 0132/G
Art. 0045/G

ASTE IN OTTONE CROMATO Ø 32 mm
Ø 32 mm CHROME BRASS POLES

ASTE IN OTTONE LUX Ø 32 mm

Ø 32 mm GOLDEN BRASS POLES

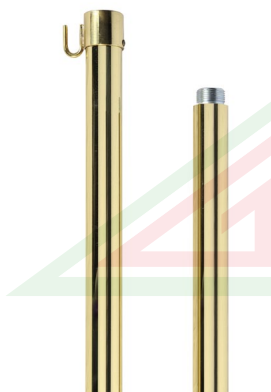

2 pezzi per bandiera
2 sections for flag

cm 200
cm 240

Art. 0130/LUX
Art. 0043/LUX

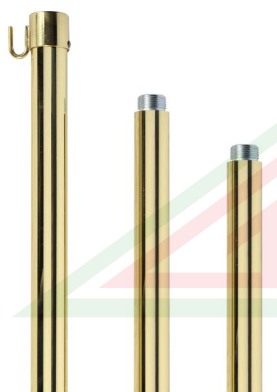

3 pezzi per bandiera
3 sections for flag

cm 250
cm 280
cm 300

Art. 0040/LUX
Art. 0132/LUX
Art. 0045/LUX



2 pezzi per gonfalone
2 sections for standard

cm 200
cm 240

Art. 0130/G/LUX
Art. 0043/G/LUX



3 pezzi per gonfalone
3 sections for standard

cm 250
cm 280
cm 300

Art. 0040/G/LUX
Art. 0132/G/LUX
Art. 0045/G/LUX

ASTE IN VELLUTO PERSONALIZZATE

CUSTOMIZED HAND MADE COVERED IN VELVET POLES



Monocolore

1 colour

1 pezzo / 1 section

2 pezzi / 2 sections

3 pezzi / 3 sections

Art. 0080

Art. 0084

Art. 0085



Bicolore

2 colours

1 pezzo / 1 section

2 pezzi / 2 sections

3 pezzi / 3 sections

Art. 0080/BIC.

Art. 0084/BIC.

Art. 0085/BIC.

Supplemento borchie a spirale

Spiral studs additional charge

Art. 0799



ASTE IN VELLUTO MILITARI DA CAPITOLATO ESERCITO E MARINA MILITARE

MILITARY FLAGPOLES ACCORDING TO NAVY/ARMY SPECIFICATIONS



Asta Bandiera di guerra Esercito
Italian Army War flagpole

Art. 0073

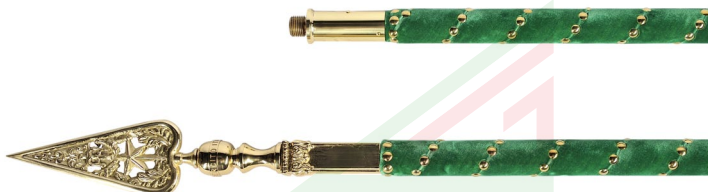

Asta Bandiera di guerra Marina Militare
Italian Navy War flagpole

Art. 0073/MA



Asta standardo Marina Militare
Italian Navy flagpole for standard

Art. 0079

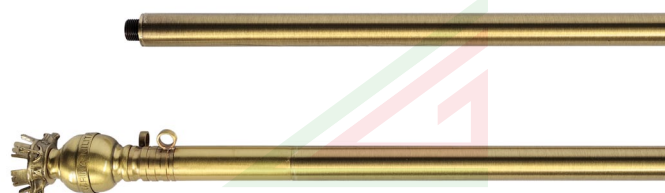

BASETTE PER BANDIERINE DA TAVOLO CON ASTINA cm 40

DESK FLAG BASES

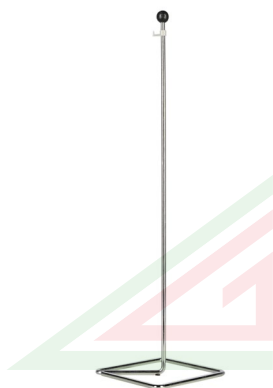

Basetta in filo cromato
Spun chrome iron desk base

Art. 0013



Basetta cromata leggera chrome
lightweight desk base

Art. 0011

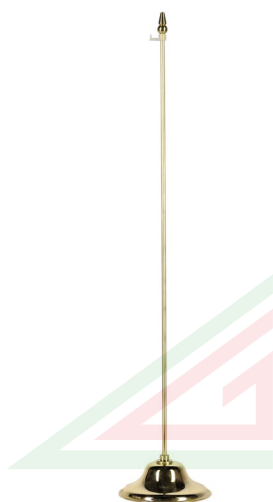

Basetta leggera ottonata
Brass-plated lightweight desk base

Art. 0011/LUX

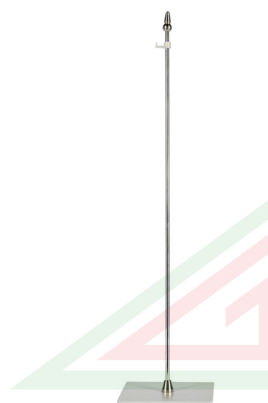

Basetta quadra 90X90 mm
90X90 mm square base

Cm 40
Cm 50
Cm 60

Art. 0034

Art. 0034/50

Art. 0034/60



Basetta quadra 90X90 mm con braccio
90X90 mm square base w/arm

Cm 40
Cm 50
Cm 60

Art. 0035

Art. 0035/50

Art. 0035/60



Basetta in legno silver

Ø 90 mm 1 posto

Ø 90 mm silver wood 1 place

Art. 0036/1



Basetta in legno silver
Ø 90 mm 2 posti
Ø 90 mm silver wood 2 places

Art. 0036/2

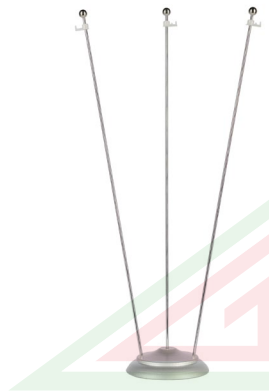

Basetta in legno silver
Ø 90 mm 3 posti
Ø 90 mm silver wood 3 places

Art. 0036/3

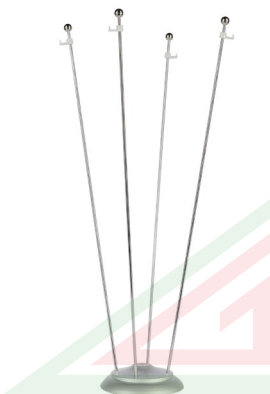

Basetta in legno silver
Ø 90 mm 4 posti
Ø 90 mm silver wood 4 places

Art. 0036/4

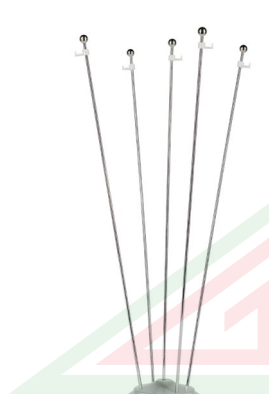

Basetta in legno silver
Ø 90 mm 5 posti
Ø 90 mm silver wood 5 places

Art. 0036/5

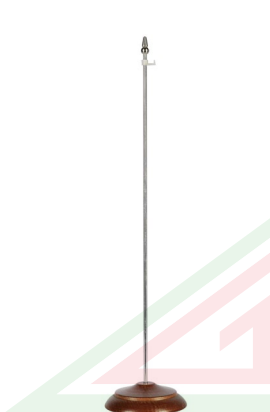

Basetta in legno colore
noce Ø 90 mm
Ø 90 mm walnut finish

Art. 0037

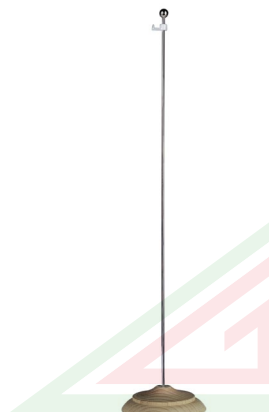

Basetta in legno
Ø 90 mm a 1 posto
Ø 90 mm wood 1 place

Art. 0038/1

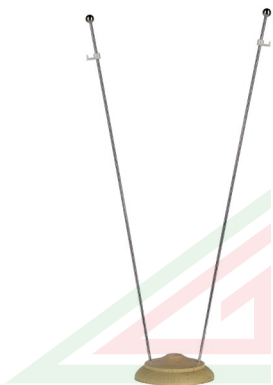

Basetta in legno
Ø 90 mm a 2 posti
Ø 90 mm wood, 2 places

Art. 0038/2



Basetta in legno
Ø 90 mm a 3 posti
Ø 90 mm wood, 3 places

Art. 0038/3

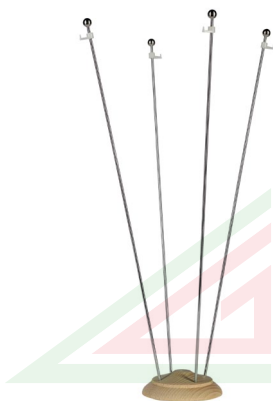

Basetta in legno
Ø 90 mm a 4 posti
Ø 90 mm wood, 4 places

Art. 0038/4

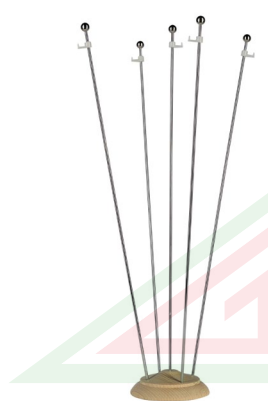

Basetta in legno
Ø 90 mm a 5 posti
Ø 90 mm wood, 5 places

Art. 0038/5

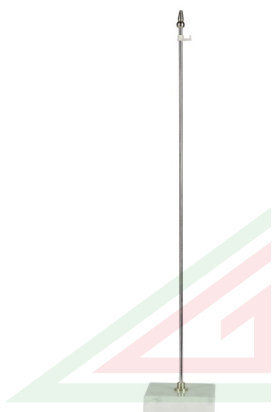

Basetta in marmo
75X75 mm a 1 posto
75X75 mm marble, 1 place

Art. 0039

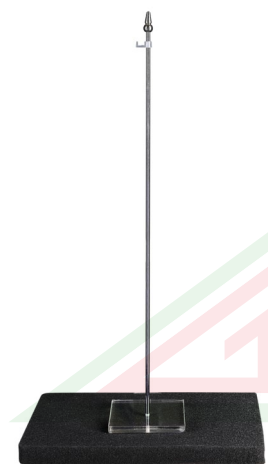

Basetta in plexiglass
90X90 mm
90X90 mm plexiglass desk base

Art. 0702



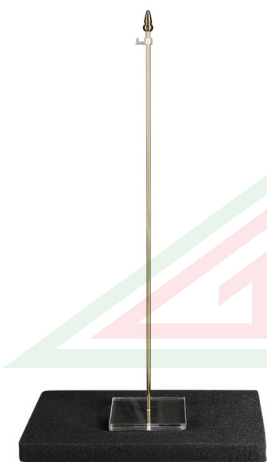

Basetta in plexiglass,
astina oro 90X90 mm **Art. 0702/LUX**
90X90 mm plexiglass desk base w/golden pole

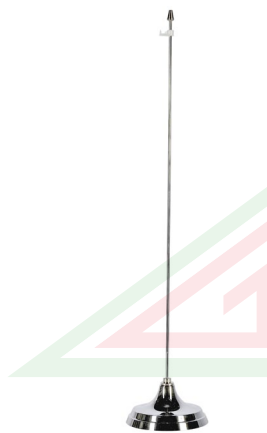

Basetta in ottone cromato 1 posto **Art. B/01**
Chrome brass desk base 1 place
Cm 50 **Art. B/01/50**
Cm 60 **Art. B/01/60**



Basetta in ottone cromato 2 posti **Art. B/02**
Chrome brass desk base 2 places

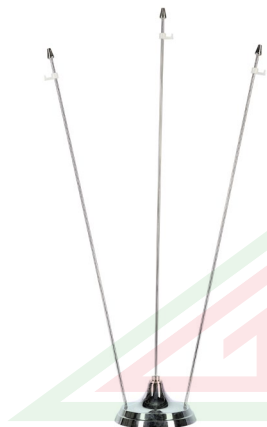

Basetta in ottone cromato 3 posti **Art. B/03**
Chrome brass desk base 3 places

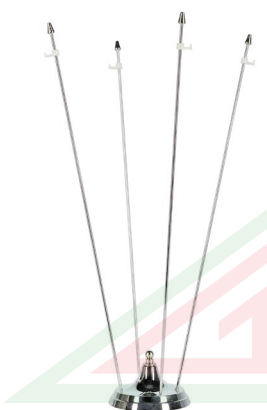

Basetta in ottone cromato 4 posti **Art. B/04**
Chrome brass desk base 4 places

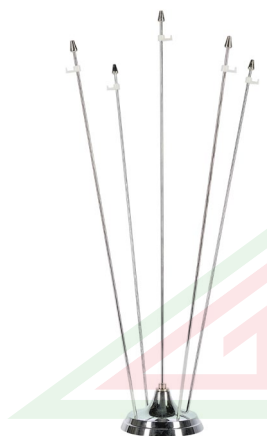

Basetta in ottone cromato 5 posti **Art. B/05**
Chrome brass desk base 5 places

Disponibili fino a 12 posti
Available up to 12 places



Basetta in ottone cromato
da 13 a 30 posti
Chromed brass desk base from 13 to 30 places

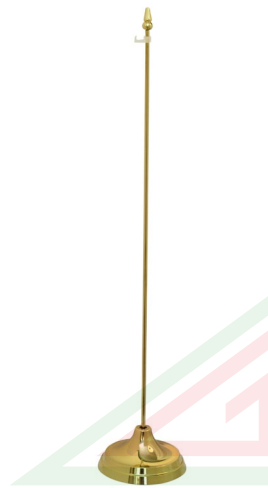

Basetta in ottone dorato 1 posto **Art. B/01/LUX**
Golden brass desk base 1 place
Cm 50 **Art. B/01/LUX/50**
Cm 60 **Art. B/01/LUX/60**



Basetta in ottone dorato
2 posti **Art. B/02/LUX**
Golden brass desk base 2 places



Basetta in ottone dorato
3 posti **Art. B/03/LUX**
Golden brass desk base 3 places

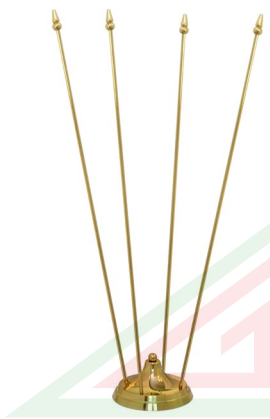

Basetta in ottone dorato
4 posti **Art. B/04/LUX**
Golden brass desk base 4 places



Basetta in ottone dorato
5 posti **Art. B/05/LUX**
Golden brass desk base 5 places



BASI DA INTERNO ECONOMICHE

ECONOMICAL INDOOR STANDS



Base cromata Ø 280 mm,
1 sede per asta Ø 22 mm **Art. 0321**
Ø 280 mm chromed, 1 place for Ø 22 mm pole

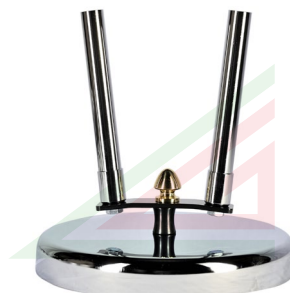

Base cromata Ø 280 mm,
2 sedi per aste Ø 22 mm **Art. 0322**
Ø 280 mm chrome base, 2 places for Ø 22 mm poles



Base cromata Ø 280 mm,
3 sedi per aste Ø 22 mm **Art. 0323**
Ø 280 mm chromed, 3 places for Ø 22 mm poles



Base cromata Ø 280 mm,
4 sedi per aste Ø 22 mm **Art. 0324**
Ø 280 mm chromed, 4 places for Ø 22 mm poles



Base cromata Ø 280 mm,
5 sedi per aste Ø 22 mm **Art. 0325**
Ø 280 mm chromed, 5 places for Ø 22 mm poles

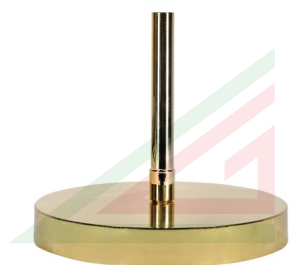

Base ottone Ø 280 mm,
1 sede per asta Ø 22 mm **Art. 0321/LUX**
Ø 280 mm brass, 1 place for Ø 22 mm poles

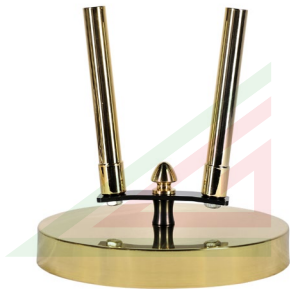

Base ottone Ø 280 mm,
2 sedi per aste Ø 22 mm **Art. 0322/LUX**
Ø 280 mm brass, 2 places for Ø 22 mm poles



base ottone Ø 280 mm,
3 sedi per aste Ø 22 mm **Art. 0323/LUX**
Ø 280 mm brass, 3 places for Ø 22 mm poles

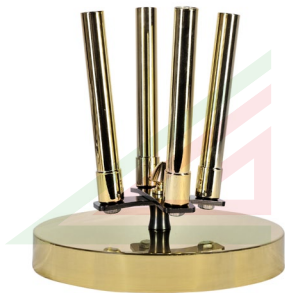

Base ottone Ø 280 mm,
4 sedi per aste Ø 22 mm **Art. 0324/LUX**
Ø 280 mm brass, 4 places for Ø 22 mm poles



Base ottone Ø 280 mm
5 posti per sedi Ø 22 mm **Art. 0325/LUX**
Ø 280 mm brass, 5 places for Ø 22 mm poles



Base cromata Ø 260 mm,
1 sede per asta Ø 22 mm **Art. 3001**
Ø 260 mm chromed, 1 place for Ø 22 mm pole



Base cromata Ø 260 mm,
2 sedi per aste Ø 22 mm **Art. 3002**
Ø 260 mm chromed, 2 places for Ø 22 mm poles





Base cromata Ø 260 mm,
3 sedi per aste Ø 22 mm **Art. 3003**
Ø 260 mm chromed, 3 places for Ø 22 mm pole



Base ottonata Ø 260 mm,
1 sede per asta Ø 22 mm **Art. 3001/LUX**
Ø 260 mm brass-plate, 1 place for Ø 22 mm pole



Base ottonata Ø 260 mm,
2 sedi per aste Ø 22 mm **Art. 3002/LUX**
Ø 260 mm brass-plate, 2 places for Ø 22 mm poles



Base ottonata Ø 260 mm,
3 sedi per aste Ø 22 mm **Art. 3003/LUX**
Ø 260 mm brass-plate, 3 places for Ø 22 mm poles



Piastra per conversione a
manicotti verticali 100 cm **Art. 0364**
cm 100 vertical mount conversion plate



Piastra per conversione a
manicotti verticali 50 cm **Art. 0358/V**
50 cm vertical mount conversion plate



ACCESSORI VARI COMPATIBILI
Replacement parts

Art. 1024



Art. 0358



Art. 0359



Art. 1201

Art. 1202
(solo per basi serie 3000)
(series 3000 only)



Art. 3020



Art. 3020/LUX

BASI DA INTERNO IN OTTONE CROMATO

CHROME BRASS INDOOR STANDS



Base Ø 280 mm,
1 sede per asta Ø 22 mm **Art. 0290**
Ø 280 mm, 1 place for Ø 22 mm pole

Per aste Ø 25 e 32 mm **Art. 0290/25**
For Ø 25 & 32 mm poles **Art. 0290/32**



Base Ø 280 mm,
2 sedi per aste Ø 22 mm **Art. 0291**
Ø 280 mm, 2 places for Ø 22 mm poles

Per aste Ø 25 e 32 mm **Art. 0291/25**
For Ø 25 & 32 mm poles **Art. 0291/32**



Base Ø 280 mm,
3 sedi per aste Ø 22 mm **Art. 0292**
Ø 280 mm, 3 places for Ø 22 mm poles

Per aste Ø 25 e 32 mm **Art. 0292/25**
For Ø 25 & 32 mm poles **Art. 0292/32**



Base nera Ø 300,
1 sede per asta Ø 22 mm **Art. 0298**
Ø black painted, 1 place for Ø 22 mm pole



Base nera Ø 300,
2 sedi per aste Ø 22 mm **Art. 0299**
Ø black painted, 2 places for Ø 22 mm poles



Base nera Ø 300,
3 sedi per aste Ø 22 mm **Art. 0300**
Ø black painted, 3 places for Ø 22 mm poles

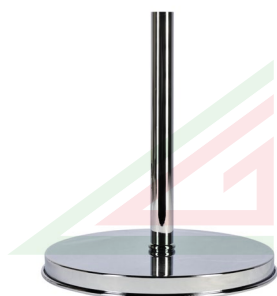

Base cromata Ø 245 mm a
1 sede per asta Ø 22 mm **Art. 0301**
Ø 245 mm chromed, 1 place for Ø 22 mm pole

Per aste Ø 25 mm **Art. 0301/25**
For Ø 25 mm poles



Base cromata Ø 245 mm a
2 sedi per aste Ø 22 mm **Art. 0302**
Ø 245 mm chromed, 2 places for Ø 22 mm poles

Per aste Ø 25 **Art. 0302/25**
For Ø 25 mm poles



Base cromata Ø 245 mm a
3 sedi per aste Ø 22 mm **Art. 0303**
Ø 245 mm chromed, 3 places for Ø 22 mm poles

Per aste Ø 25 **Art. 0303/25**
For Ø 25 mm poles



Base cromata Ø 315 a
1 sede per asta Ø 22 mm **Art. 0308**
Ø 315 mm, 1 place for Ø 22 mm pole

Per aste Ø 25/32/35 mm **Art. 0308/25**
For Ø 25/32/35 mm poles **Art. 0308/32**
Art. 0308/35

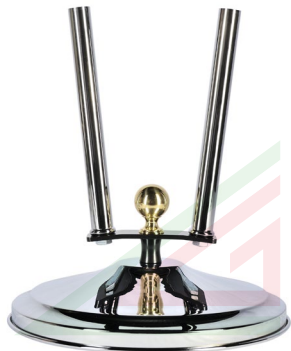

Base cromata Ø 315 a
2 sedi per aste Ø 22 mm **Art. 0309**
Ø 315 mm, 2 places for Ø 22 mm poles

Per aste Ø 25/32/35 mm **Art. 0309/25**
For Ø 25/32/35 mm poles **Art. 0309/32**
Art. 0309/35



Base cromata Ø 315 a
3 sedi per aste Ø 22 mm **Art. 0310**
Ø 315 mm, 3 places for Ø 22 mm poles

Per aste Ø 25/32/35 mm **Art. 0310/25**
For Ø 25/32/35 mm poles **Art. 0310/32**
Art. 0310/35

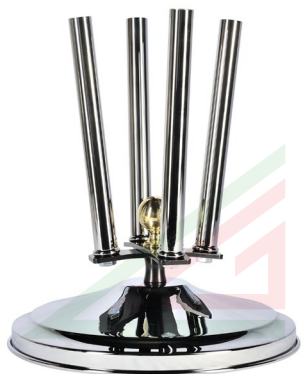

Base cromata Ø 315 a
4 sedi per aste Ø 22 mm **Art. 0311**
Ø 315 mm, 4 places for Ø 22 mm poles

Per aste Ø 25/32 mm **Art. 0311/25**
For Ø 25/32 mm poles **Art. 0311/32**



Base cromata Ø 315 a
5 sedi per aste Ø 22 mm **Art. 0312**
Ø 315 mm, 5 places for Ø 22 mm poles

Per aste Ø 25/32 mm **Art. 0312/25**
For Ø 25/32 mm poles **Art. 0312/32**

BASI DA INTERNO IN OTTONE LUCIDO

GOLDEN BRASS INDOOR STANDS

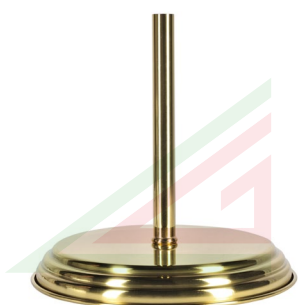

Base Ø 280 mm,
1 sede per asta Ø 22 mm **Art. 0290/LUX**
Ø 280 mm, 1 place for Ø 22 mm pole

Per aste Ø 25 e 32 mm **Art. 0290/LUX/25**
For Ø 25 & 32 mm poles **Art. 0290/LUX/32**



Base Ø 280 mm,
2 sedi per aste Ø 22 mm **Art. 0291/LUX**
Ø 280 mm, 2 places for Ø 22 mm poles

Per aste Ø 25 e 32 mm **Art. 0291/LUX/25**
For Ø 25 & 32 mm poles **Art. 0291/LUX/32**



Base Ø 280 mm,
3 sedi per aste Ø 22 mm **Art. 0292/LUX**
Ø 280 mm, 3 places for Ø 22 mm poles

Per aste Ø 25 e 32 mm **Art. 0292/LUX/25**
For Ø 25 & 32 mm poles **Art. 0292/LUX/32**

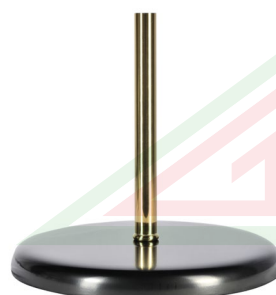

Base nera Ø 300,
1 sede per asta Ø 22 mm **Art. 0298/LUX**
Ø black painted, 1 place for Ø 22 mm pole



Base nera Ø 300,
2 sedi per aste Ø 22 mm **Art. 0299/LUX**
Ø black painted, 2 places for Ø 22 mm poles



Base nera Ø 300,
3 sedi per aste Ø 22 mm **Art. 0300/LUX**
Ø black painted, 3 places for Ø 22 mm poles





Base Ø 245 mm a 1 sede
per asta Ø 22 mm **Art. 0301/LUX**
Ø 245 mm, 1 place for Ø 22 mm pole

Per aste Ø 25 mm **Art. 0301/LUX/25**
For Ø 25 mm pole



Base Ø 245 mm a 2 sedì
per aste Ø 22 mm **Art. 0302/LUX**
Ø 245 mm, 2 places for Ø 22 mm poles

Per aste Ø 25 mm **Art. 0302/LUX/25**
For Ø 25 mm poles



Base Ø 245 mm a 3 sedì
per asta Ø 22 mm **Art. 0303/LUX**
Ø 245 mm, 3 places for Ø 22 mm pole

Per aste Ø 25 mm **Art. 0303/LUX/25**
For Ø 25 mm poles



Base Ø 315 a 1 sede
per asta Ø 22 mm **Art. 308/LUX**
Ø 315 mm, 1 place for Ø 22 mm pole

Per aste Ø 25/32/35 mm **Art. 0308/LUX/25**
For Ø 25/32/35 mm poles **Art. 0308/LUX/32**
Art. 0308/LUX/35



Base Ø 315 a 2 sedì
per asta Ø 22 mm **Art. 309/LUX**
Ø 315 mm, 2 places for Ø 22 mm poles

Per aste Ø 25/32/35 mm **Art. 0309/LUX/25**
For Ø 25/32/35 mm poles **Art. 0309/LUX/32**
Art. 0309/LUX/35



Base Ø 315 a 3 sedì
per aste Ø 22 mm **Art. 310/LUX**
Ø 315 mm, 3 places for Ø 22 mm poles

Per aste Ø 25/32/35 mm **Art. 0310/LUX/25**
For Ø 25/32/35 mm poles **Art. 0310/LUX/32**
Art. 0310/LUX/35



Base Ø 315 a 4 sedi
per aste Ø 22 mm **Art. 311/LUX**
Ø 315 mm, 4 places for Ø 22 mm poles

Per aste Ø 25/32 mm **Art. 0311/LUX/25**
For Ø 25/32 mm poles **Art. 0311/LUX/32**



Base Ø 315 a 5 sedi
per aste Ø 22 mm **Art. 312/LUX**
Ø 315 mm, 5 places for Ø 22 mm poles

Per aste Ø 25/32 mm **Art. 0312/LUX/25**
For Ø 25/32 mm poles **Art. 0312/LUX/32**

ACCESSORI VARI COMPATIBILI *Replacement parts*

Art. 0360



Art. 0368



Art. 0359



Art. 1201



Art. 1202
solo per / Only for
Art. 0308 - 0309 - 0310
0311 - 0312



Art. 0350



Art. 0350/LUX



BASI PER ESTERNO

OUTDOOR STANDS

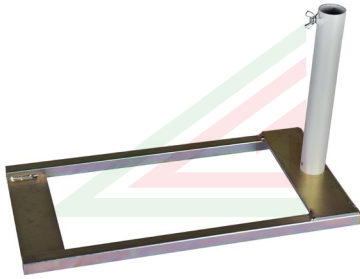

Base sottoruota
per asta Ø 32 mm **Art. 0008**
Wheel car stand for Ø 32 mm flagpole

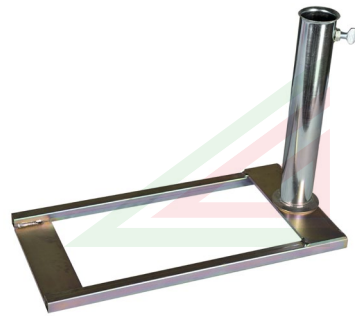

Base sottoruota
per asta Ø 50 mm **Art. 008/50**
Wheel car stand for Ø 50 mm flagpole



Base sottoruota con asta
telescopica, 5,50 mt **Art. 0343**
Wheel car stand w/telescopic flagpole, 5,50 mt

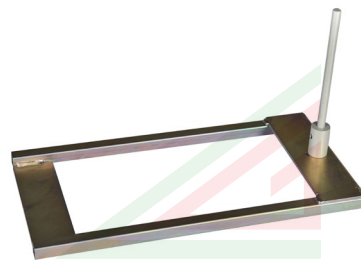

Base sottoruota
per aste a vela e goccia **Art. 0340**
Wheel car stand for drop/sail frame

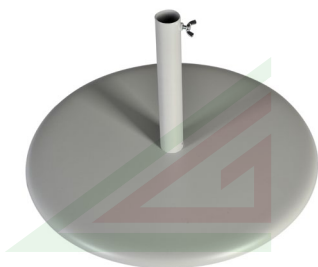

Base in ferro
Ø 380 mm, 7 kg **Art. 0328**
Ø 380 mm iron stand, 7 kg
Ø 500 mm, 10 kg **Art. 0329**
Ø 500 mm iron stand, 10 kg

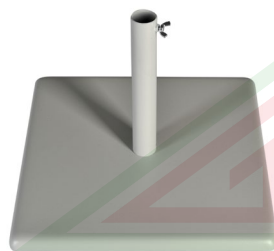

Base in ferro
400X400 mm, kg 9 **Art. 0335**
400X400 mm iron stand, kg 9



Base in cemento granagliato
Ø 520 mm, 35 kg **Art. 0331/35**
Ø 520 mm cement stand, 35 kg
Ø 650 mm, 70 kg **Art. 0331/70**
Ø 650 mm, 70 kg



Base riempibile
480X480 mm, kg 20 **Art. 0333**
480X480 mm water base, kg 20

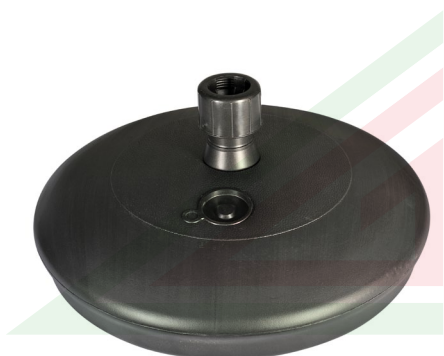

Base riempibile Ø 580 mm
per aste Ø 32 mm kg 30 **Art. 0327**
Ø 580 mm water base,
Kg 30 for Ø 32 mm flagpole

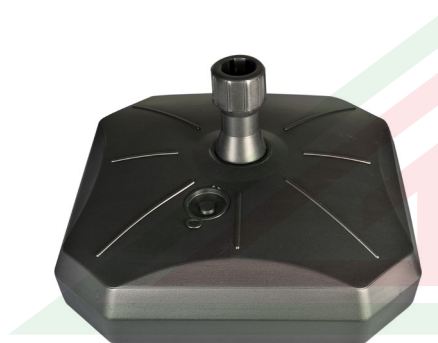

Base riempibile 600X600 mm
per aste Ø 32/50 mm, kg 50 **Art. 0334**
600X600 mm water base
for Ø 32/50 mm flagpole, kg 50





Base riempibile 100X100 cm
con asta telescopica 5,5 mt **Art. 0345**
*100X100 cm water base with
5,5 mt telescopic flagpole*

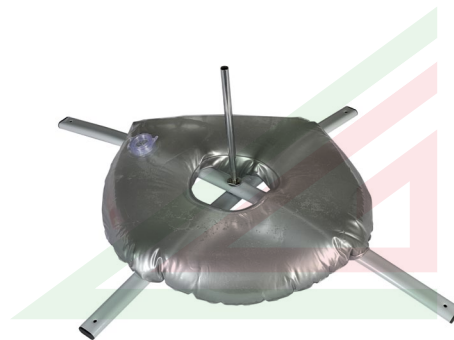

Base a croce per aste
a goccia/vela **Art. 0330**
Zavorra a ciambella **Art. 0330-C**
*Cross stand for drop/sail frame
Ring shape weight*

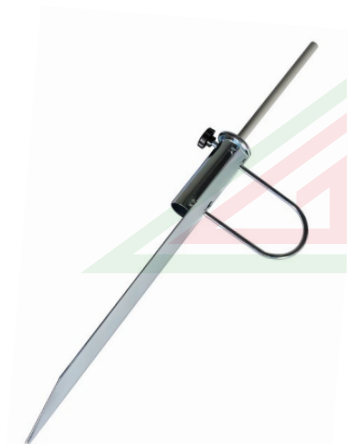

Picchetto per aste
a goccia/vela **Art. 0332**
Stake for drop/sail frame

BORSE E CINTURONI

BAGS & CARRYING FLAG BELT



Borsa bandiera 20X80 cm **Art. 0004**
20X80 cm flag bag

Borsa bandiera 15X100 cm **Art. 0002**
15X100 cm flag Bag



Borsa porta standardo 25X125 cm economica **Art. 0005/E 125**
Borsa porta standardo 25X100 cm economica **Art. 0005/E**
Borsa porta standardo 25X100 cm rinforzata **Art. 0005**
*25X100 cm reinforced/soft bag
for standard and 25X125 cm*



Borsa porta gonfalone rigida **Art. 0001/cm 110**
Art. 0001/cm124
Hard bag for standard 20X110 – 20X124



Borsa porta base cm 30X30X30 **Art. 0006**
cm 30X30X30 hard bag for stand



Cinturone regolabile reggi asta **Art. 0003**
Adjustable carrying flag belt

TRAVERSE PER LABARI E GONFALONI SILVER

CHROMED CROSS-BARS FOR STANDARDS



Sistema innovativo brevettato, evitando la saldatura diretta sul tubo garantisce la massima robustezza anche con gonfaloni e medaglieri molto pesanti.

Patented innovative system, no welding on tube, maximum strength with very heavy standards and medal collection too.

NOVITÀ



Traversa satinata alluminio cm 60/100 **Art. 0048**
cm 60 to 100 satin silver aluminium with chrome brass rings

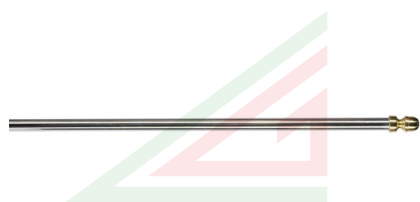

Traversa semplice in ottone cromato **Art. 0050**
Ø 15 mm max 100 cm
Ø 15 mm chrome brass basic cross-bar, max 100 cm

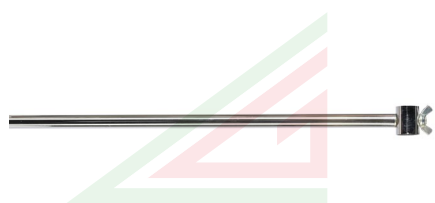

Traversa a sbalzo in ottone cromato Ø 15 mm **Art. 0051**
Ø 15 mm chrome brass cantilever cross-bar

TRAVERSE IN OTTONE CROMATO CHROME BRASS CROSS-BARS

Da cm 50 a 85 Ø 15 mm
Ø 15 mm from cm 50 to 85



Da cm 90 a 110 Ø 22 mm
Ø 22 mm from cm 90 to 110



cm 50	Art. 0052
cm 55	Art. 0053
cm 60	Art. 0054
cm 65	Art. 0055
cm 70	Art. 0056
cm 75	Art. 0057
cm 80	Art. 0058
cm 85	Art. 0059
cm 90	Art. 0060
cm 95	Art. 0061
cm 100	Art. 0062
cm 105	Art. 0063
cm 110	Art. 0064

Le misure si riferiscono utili da anello ad anello
Overall length between rings



TRAVERSE DORATE PER LABARI E GONFALONI

GOLDEN CROSS-BARS FOR STANDARDS

NOVITÀ



Traversa in alluminio anodizzato oro
con particolari in ottone. cm 60/100

Art. 0048/LUX

*Anodized aluminium, golden,
with brass rings cross-bar cm 60 to 100*

TRAVERSE IN OTTONE LUCIDO

GOLDEN BRASS CROSS-BARS



Da cm 50 a 85 Ø 15 mm
Ø 15 mm from cm 50 to 85



Da cm 90 a 110 Ø 22 mm
Ø 22 mm from cm 90 to 110

cm 50	Art. 0052/LUX
cm 55	Art. 0053/LUX
cm 60	Art. 0054/LUX
cm 65	Art. 0055/LUX
cm 70	Art. 0056/LUX
cm 75	Art. 0057/LUX
cm 80	Art. 0058/LUX
cm 85	Art. 0059/LUX
cm 90	Art. 0060/LUX
cm 95	Art. 0061/LUX
cm 100	Art. 0062/LUX
cm 105	Art. 0063/LUX
cm 110	Art. 0064/LUX
cm 115	Art. 0065/LUX
cm 120	Art. 0066/LUX
cm 125	Art. 0067/LUX
cm 130	Art. 0068/LUX
cm 135	Art. 0069/LUX
cm 140	Art. 0070/LUX
cm 145	Art. 0071/LUX
cm 150	Art. 0072/LUX

POMOLI PER ASTE E TERMINALI PER TRAVERSE IN OTTONE

BRASS BALLS FOR FLAGPOLES & FINIALS FOR CROSS-BARS

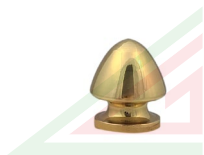

Pomolo conico Ø 30 mm
Ø 30 mm conical finial
Art. 1024



Terminale Ø 35 mm
Ø 35 mm finial
Art. 1025



Terminale Ø 30 mm
Ø 30 mm finial
Art. 1026

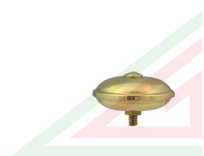

Pomolo schiacciato
Ø 50 mm
Ø 50 mm flat finial
Art. 0104/50

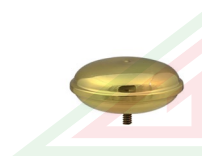

Pomolo schiacciato
Ø 70 mm
Ø 70 mm flat finial
Art. 0104/70

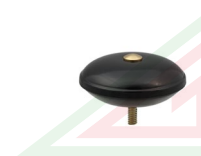

Pomolo schiacciato nero
Ø 50 mm
Ø 50 mm flat finial, black
Art. 0104/NE



Terminale Ø 40 mm
Ø 40 mm finial
Art. 0360



Terminale cromato
Ø 40 mm
Ø 40 mm chromed finial
Art. 0360/C



Terminale Ø 41 mm
Ø 41 mm finial
Art. 0019

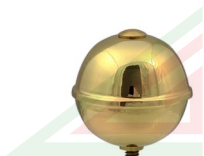

Pomolo Ø 50 mm
Ø 50 mm ball
Art. 0098



Pomolo Ø 50 mm
Ø 50 mm chromed ball
Art. 0098/C



Pomolo Ø 60 mm
Ø 60 mm ball
Art. 0103

POMOLI PER ASTE E TERMINALI PER TRAVERSE IN OTTONE
BRASS BALLS FOR FLAGPOLES & FINIALS FOR CROSS-BARS



Pomolo cromato Ø 60 mm
Ø 60 mm chromed ball
Art. 0103/C

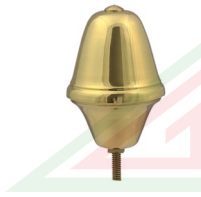

Terminale Ø 60 mm
Ø 60 mm finial
Art. 0137

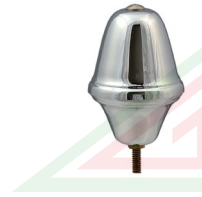

Terminale cromato Ø 60 mm
Ø 60 mm chromed finial
Art. 0137/C



Pomolo Ø 70 mm
Ø 70 mm ball
Art. 102



Pomolo cromato Ø 70 mm
Ø 70 mm chromed Ball
Art. 102/C

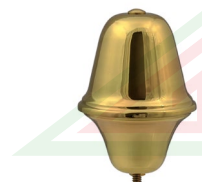

Terminale Ø 80 mm
Ø 60 mm finial
Art. 0138



Terminale Ø 80 mm
Ø 60 mm chromed finial
Art. 0138/C



Pomolo con gambo Ø 65 mm
Ø 65 mm ball w/stem
Art. 0100



Pomolo cromato con
gambo Ø 65 mm
Ø 65 mm ball w/stem
Art. 0100/C

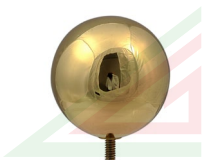

Pomolo Ø 65 mm
Ø 65 mm ball
Art. 0101

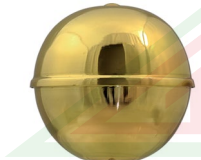

Pomolo Ø 100 mm
Ø 100 mm ball
Art. 0112



Pomolo cromato Ø 100 mm
Ø 100 mm chromed ball
Art. 0112/C

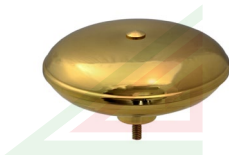

Pomolo Ø 120 mm
Ø 120 mm finial

Art. 0105

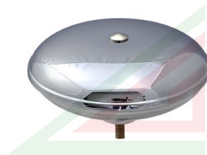

Pomolo cromato
Ø 120 mm
Ø 120 mm chromed finial

Art. 0105/C

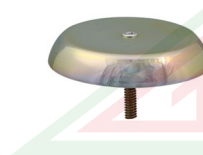

Testarolo zincato per
aste Ø 32 mm
Galvanized Iron finial for
Ø 32 mm flagpole

Art. 0550

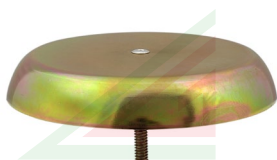

Testarolo zincato per
aste Ø 50 mm
Galvanized iron finial for
Ø 50 mm flagpole

Art. 0551



Pomolo Ø 130 mm
Ø 130 mm ball

Art. 0099



Pomolo cromato Ø 130 mm
Ø 130 mm chromed ball

Art. 0099/C

**POMOLI PER ASTE E TERMINALI PER TRAVERSE IN OTTONE
BRASS BALLS FOR FLAGPOLES & FINIALS FOR CROSS-BARS**

LANCE ED EMBLEMI IN OTTONE

BRASS SPEARHEADS AND EMBLEMS



Lancia generica economica
Generic spearhead
Art. 0120/E



Lancia generica
Generic spearhead
Art. 0120



Lancia generica cromata
Chromed generic spearhead
Art. 0120/C



Lancia Repubblica Italiana
Art. 0115/L



Emblema Repubblica
Italiana economico
Art. 0115/E



Emblema Repubblica
Italiana
Art. 0115



Lancia generica grande
Big generic spearhead
Art. 0125



Lancia generica grande
cromata
Big chromed generic spearhead
Art. 0125/C



Lancia con stella economica
Economic spearhead with star
Art. 0116/E



Lancia Repubblica con
stella
Republic spearhead with star
Art. 0116



Emblema aquila ali
aperte
Wide open wings eagle
Art. 0107



Emblema aquila in volo
Flying eagle emblem
Art. 0153



Lancia Guardia di Finanza

Art. 0119



Lancia Polizia di Stato
State Police spearhead

Art. 0129



Lancia Vigili del Fuoco
Firefighters spearhead

Art. 0141



Lancia Croce Rossa
Red Cross spearhead

Art. 0147



Emblema Unione Europea
European Union emblem

Art. 0134



Lancia Unione Europea
European Union spearhead

Art. 0134/L



Emblema Carabinieri

Art. 0108



Lancia Carabinieri

Art. 0108/L



Emblema Bersaglieri

Art. 0109



Lancia Paracadutisti
Paratrooper spearhead

Art. 0117



Emblema ancora marina
Marine Anchor Emblem

Art. 0123



Lancia Combattenti e Reduci
Veteran's spearhead

Art. 0118



Emblema corona alloro
Crowned emblem
Art. 0106



Emblema Olimpico
Olympic emblem
Art. 0375

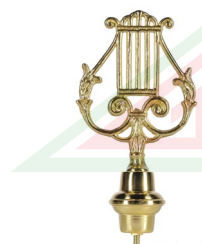

Emblema musicale
Musical emblem
Art. 0110



Emblema stella grande
A.N.P.I.
Big star emblem
Art. 0111



Emblema A.V.I.S.
Art. 0121

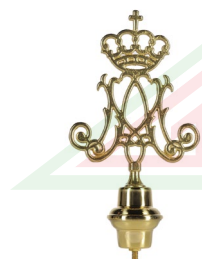

Emblema Mariano
Art. 0135



Croce
Cross

Art. 0144



Croce grande
Big Cross

Art. 0151



Croce cromata
Chromed Cross

Art. 0150



Emblema U.N.I.T.A.L.S.I.
Art. 0136



Emblema invalidi
di guerra

Art. 0145



Emblema invalidi
del lavoro

Art. 0124

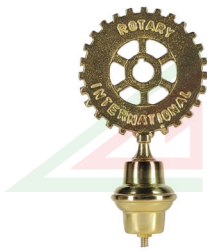

Emblema Rotary
International
Art. 0152



Emblema Lions
International
Art. 0155



Emblema Leo
Art. 0157



Emblema Ghirlanda
Garland Emblem
Art. 0154



Lancia a freccia
Arrow spearhead
Art. 0156

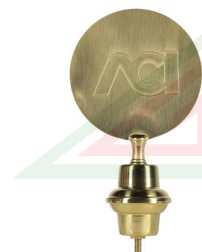

Emblema personalizzato
Customized emblem
Art. 0133



Lancia piatta neutra
Blank flat spearhead
Art. 0113

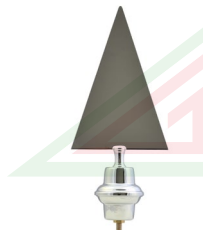

Lancia piatta neutra
cromata
Chromed blank flat spearhead
Art. 0113/C

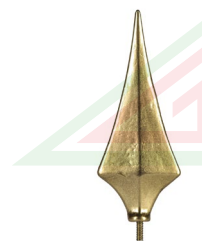

Lancia a punta
Classic spearhead
Art. 0114



Lancia-pomolo in rame
Copper finial
Art. 0127



Lancia statuto militare
come da capitolato
Esercito Italiano
Guardia di Finanza
Arma dei Carabinieri
Aeronautica Militare
Corpo di Polizia
Penitenziaria
Art. 0131



Lancia Marina Militare
Art. 0131/M



Emblema Marina
Militare
Art. 0131/MA

SU RICHIESTA REALIZZIAMO SU CAMPIONATURA QUALSIASI LANCIA O EMBLEMA
BY REQUEST WE CAN REALIZE ANY SPEARHEAD OR EMBLEM



Lancia Personalizzata incisione bifacciale **Art. 0122**

*Customized spearhead
Both sides engraved*

Dimensioni lancia
Spearhead dimensions

13 X 33 cm

Dimensioni stemma
Badge dimensions

6 X 11 cm

LINEA FERRO BATTUTO

WROUGHT IRON STYLE LINE



Traversa da parete (misure a richiesta)
Wall cross-bar (dimensions by request)

Art. 0180



Asta Ø 22 mm verniciata cm 200
Ø 22 mm painted flagpole, cm 200

Art. 0200/A



Asta alluminio verniciata cm 200 Ø 32 mm
con ganci
Ø 32 mm painted aluminium flagpole cm 200 w/hooks

Art. 0399/A

Asta alluminio verniciata cm 250 Ø 32
con ganci
Ø 32 mm painted aluminium flagpole, cm 250 w/hooks

Art. 0400/A

Asta alluminio verniciata cm 300 Ø 32 mm
con ganci
Ø 32 mm painted aluminium flagpole, cm 300 w/hooks

Art. 0450/A



Asta alluminio verniciata, cm 250 Ø 32 mm
con carrucola
Ø 32 mm painted aluminium flagpole cm 250 w/pulley

Art. 0401/A

Asta alluminio verniciata, cm 300 Ø 32 mm
con carrucola
Ø 32 mm painted aluminium flagpole cm 300 w/pulley

Art. 451/A



Supporto da parete ferro battuto cm 70
cm 70 wrought-iron wall bracket

Art. 0258



Base in ferro battuto per asta Ø 22 mm
Wrought-iron stand for Ø 22 mm flagpole

Art. 0254



Supporto ferro battuto per asta Ø 32 mm
Wrought-iron wall bracket for Ø 32 mm pole

Art. 0253/1



Supporto ferro battuto a 2 posti
per aste Ø 32 mm

Wrought-iron wall bracket, 2 places for Ø 32 mm poles

Art. 0253/2



Supporto ferro battuto a 3 posti
per aste Ø 32 mm

Wrought-iron wall bracket, 3 places, for Ø 32 mm poles

Art. 0253/3

BASE E SUPPORTI MODELLO DEPOSITATO
STAND & WALL BRACKETS REGISTERED MODELS

LINEA ACCIAIO INOX

STAINLESS-STEEL LINE

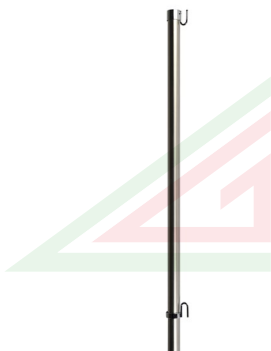

Aste Ø 25 mm
Ø 25 mm flagpoles

cm 150
cm 200
cm 250
cm 300

Art. 0210
Art. 0211
Art. 0212
Art. 0213



Pomolo Ø 25 mm
Ø 25 mm knob

Art. 0214

Puntale Ø 25 mm
Ø 25 mm conical top

Art. 0215

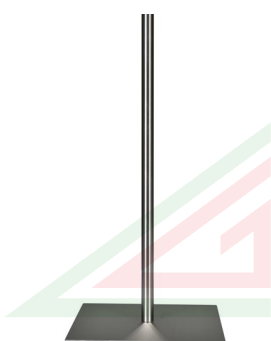

Base a 1 sede cm 30X30
cm 30X30 1 place stand

Art. 0216

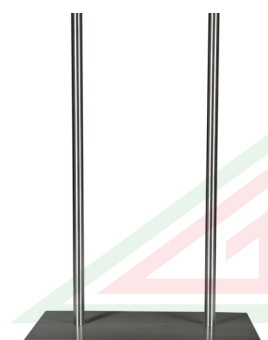

Base a 2 sedi cm 30X50
cm 30X50 2 places stand

Art. 0217

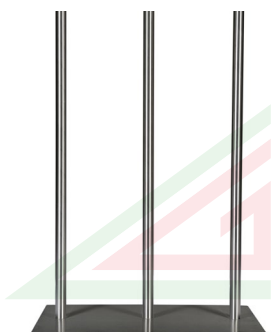

Base a 3 sedi cm 30X50
cm 30X50 3 places stand

Art. 0218

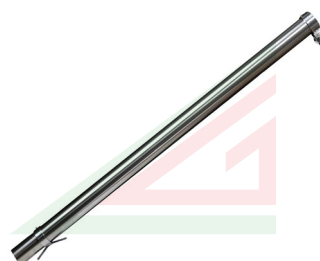

Asta Ø 50 mm con carrucola
Ø 50 mm flagpole w/pulley

Cm 300
Cm 400

Art. 0261
Art. 0262





Cavetto inox con morsetti
per asta Ø 50 mm
*Stainless-steel line with clamps
for Ø 50 mm flagpoles*

Art. 0259



Supporto orizzontale
cm 60/80/100
*cm 60/80/100 horizontal
wall-mount*

Art. 0256

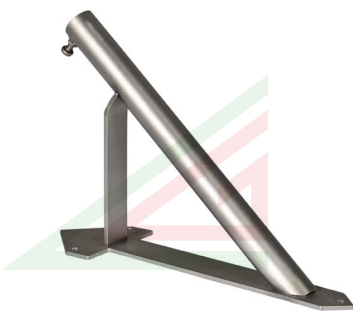

Supporto a muro,
1 posto per aste Ø 25 mm
*Wall bracket, 1 place
for Ø 25 mm flagpole*

Art. 0025/1



Supporto a muro,
2 posti per aste Ø 25 mm
*Wall bracket, 2 places
for Ø 25 mm flagpoles*

Art. 0025/2



Supporto a muro,
3 posto per aste Ø 25 mm
*Wall bracket, 3 places
for Ø 25 mm flagpoles*

Art. 0025/3



Supporto angolare a
1 posto per asta Ø 25 mm
*Angle wall bracket, 1 place
for Ø 25 mm flagpole*

Art. 0026/1

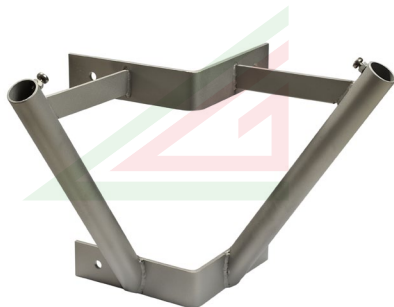

Supporto angolare a
2 posti per aste Ø 25 mm **Art. 0026/2**
Angle wall bracket, 2 places for Ø 25 mm flagpoles

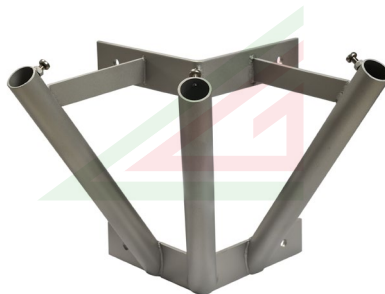

Supporto angolare a
3 posti per aste Ø 25 mm **Art. 0026/3**
Angle wall bracket, 3 places for Ø 25 mm flagpoles

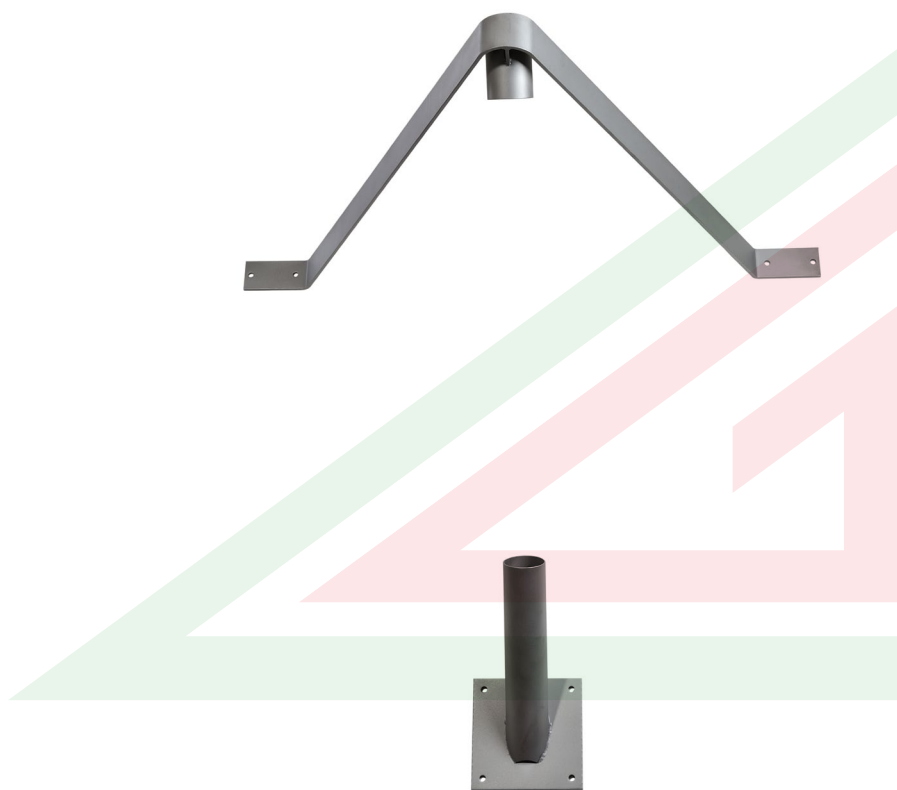

Supporto per asta Ø 50 mm
2 piece wall bracket for Ø 50 mm flagpole

Art. 0027

SUPPORTI DA PARETE E ACCESSORI PER ESTERNO

WALL MOUNT BRACKETS & OUTDOOR ACCESSORIES

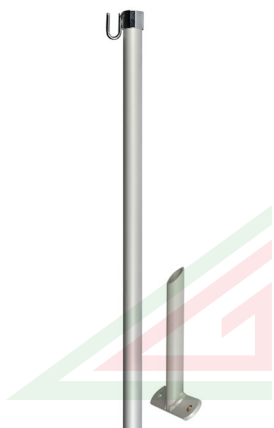

Supporto con asta Ø 22, cm 150

Art. 0020

Wall bracket, Ø 22 mm cm 150 flagpole included

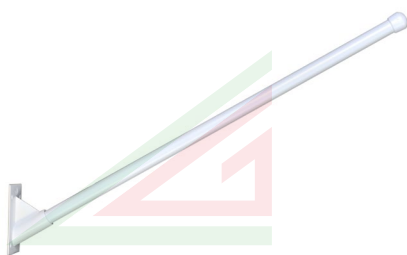

Supporto in plastica con asta cm 60

Art. 0021

Plastic bracket with cm 60 pole



Staffa inclinata per pali con asta cm 80

Art. 0020/50

*Diagonal bracket pole-mounted,
cm 80 flagpole included*



Staffa orizzontale per pali con asta cm 80

Art. 0020/90

*Horizontal bracket pole-mounted,
cm 80 flagpole included*

SUPPORTI PER ASTE Ø 22 mm
Wall mount brackets for Ø 22 mm poles



Art. 022/1



Art. 022/2



Art. 022/3

SUPPORTI A MURO PER ASTE Ø 32 mm
Wall mount brackets for Ø 32 mm flagpoles



Art. 0250

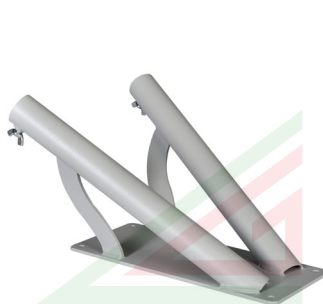

Art. 0250/2



Art. 0250/3



Art. 0250/4

Tutti i supporti sono realizzati con taglio laser e saldature robotizzate, zincati e verniciati in polvere poliesteri.



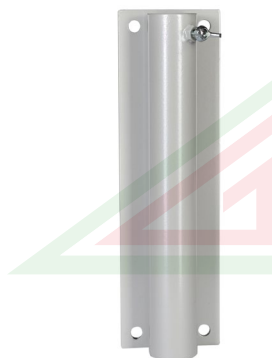

Supporto verticale per asta Ø 32 mm **Art. 0251**
Vertical wall mount bracket for Ø 32 mm flagpole



Supporto da muro/pavimento per aste Ø 32 mm **Art. 0252**
Horizontal/vertical mount bracket for Ø 32 mm



Supporto orizzontale in ottone cm 65 **Art. 0255**
cm 65 horizontal brass-bracket



Supporto per aste Ø 50 mm **Art. 0260**
Wall mount bracket for Ø 50 mm flagpole

SALVAMURO INOX BREVETTATI

Patented stainless steel anti-rust plates

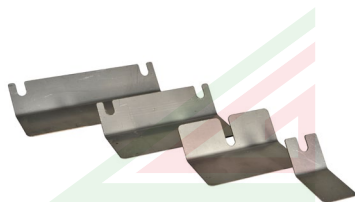
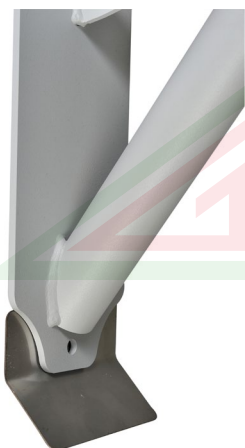

Salvamuro in acciaio inox
Stainless steel anti-rust plate

Per supporti a 1 posto
For 1 place bracket

Art. 0270/1

Per supporti a 2 e 3 posti
For 2-3 places bracket

Art. 0270/2/3

Per supporti a 4 posti
For 4 places bracket

Art. 0270/4

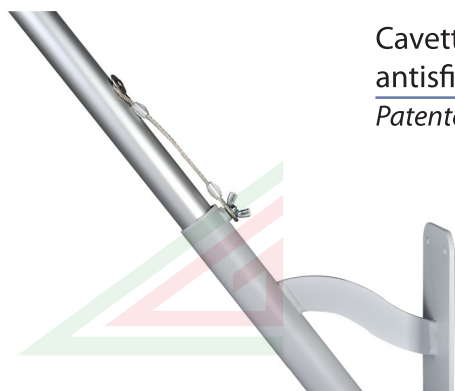

Cavetto inox di sicurezza
antisfilamento brevettato
Patented stainless steel safety line

Art. 0556

PENNONI E ACCESSORI

FLAGPOLES AND ACCESSORIES

Alluminio anodizzato a 15 μ , anti ruggine, lega 60/63, certificato ISO

SU RICHIESTA COLORAZIONE PERSONALIZZATA

Rust-free 15 μ anodized aluminium, 60/63 alloy, ISO certify.

BY REQUEST CUSTOMIZED COLORATION

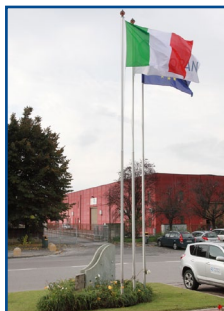

Mt. 5 Ø 65/50
Mt. 6 Ø 65/50
Mt. 6 Ø 80/65
Mt. 7 Ø 80/65/50
Mt. 8 Ø 80/65/50
Mt. 9 Ø 100/80/65/50
Mt. 10 Ø 100/80/65/50

Art. ALL.05
Art. ALL.06
Art. ALL.0600
Art. ALL.0700
Art. ALL.0800
Art. ALL.0900
Art. ALL.1000

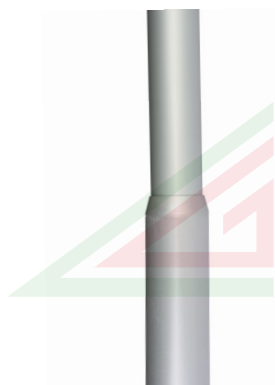

Ogni pennone serie "ALL" viene fornito completo di:

- Pomolo di rifinitura (oro o argento)
- Fune
- Bitta
- Istruzioni di montaggio
- Sistema scorrimento fune

"ALL" series contents:

- Golden or silver finial
- Halyard with flag snap - hook
- Cleat
- Instructions
- Sliding halyard system

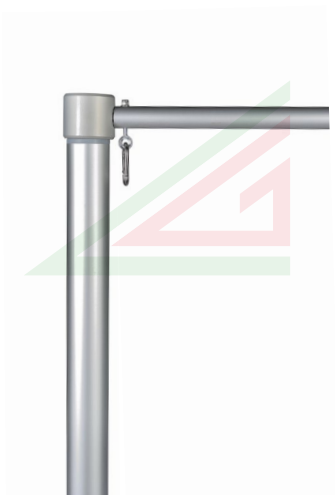

Braccio girevole per pennoni Ø 50 - 65 mm **Art. 0531**
Revolving arm for Ø 50 - 65 mm flagpoles



Sistema ISS fune interna **Art. 0533**
Internal halyard system

Dotazione standard pennoni



Art. 0099

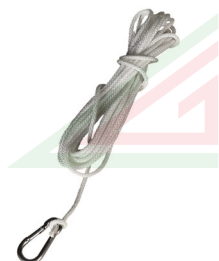

Art. 0363/P

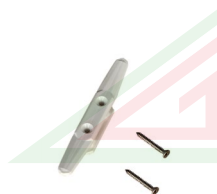

Art. 0558

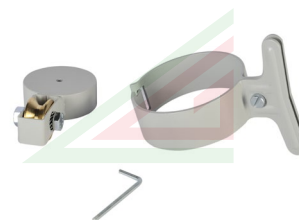

Art. 0365/80



Peso tendi bandiera
Counterweight

Art. 0366/0200gr
Art. 0366/0500gr
Art. 0366/1000gr

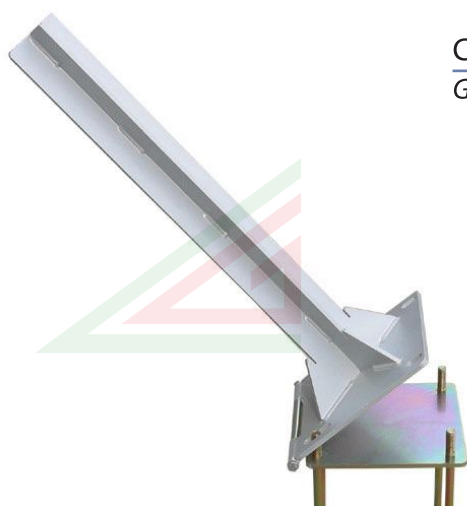

Cerniera zincata per pennone Ø 80 mm
Galvanized hinge plate for Ø 80 mm flagpoles

Art. 0370

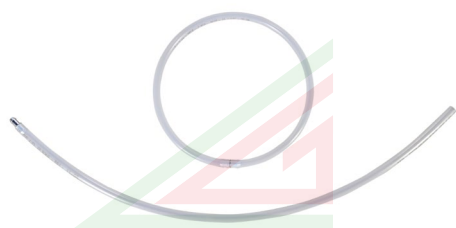

Anello per pennoni
Ring for flagpoles

Art. 0368



Anello per pennoni riapribile
Openable ring for flagpoles

Art. 0368/R

PENNONI IN VETRORESINA

Fiberglass flagpoles

Tra i migliori pennoni in vetroresina sul mercato mondiale, rinforzati in poliestere, testati a 237,6 km/h, eccezionali dalla struttura fino alla singola vite della galloccia in acciaio inox, tutti dotati di cerniera zincata a caldo ribaltabile.

Orgogliosi di vendere un prodotto scelto per eventi di alto profilo come, tra gli altri, le Olimpiadi di Sidney, Olimpiadi Invernali di Vancouver per non parlare del fatto che potete ammirare questi pennoni davanti al palazzo delle Nazioni Unite di Vienna e alla Casa Bianca di Washington D.C.

One of the world's leading fiberglass-reinforced polyester flagpoles, tested at 237,6 km/h, the highest quality from the pole to the cleat's stainless-screws, all hinge plate equipped. Proud to sell a flagpole that supplied to high-profile events like Sydney Olympics, Vancouver Olympics, not to mention, these flagpoles standing tall outside buildings the White House in Washington D.C. and the United Nations in Vienna.





Misure disponibili

Available dimensions

6 mt	Art. VTR0600
7 mt	Art. VTR0700
8 mt	Art. VTR0800
9 mt	Art. VTR0900
10 mt	Art. VTR1000
12 mt	Art. VTR1200

SU RICHIESTA COLORAZIONE PERSONALIZZATA
BY REQUEST CUSTOMIZED COLORATION



Sistema ISS fune interna

Art. 0533

Internal halyard system



Braccio issabile

(solo per pennoni con sistema ISS)

Art. 0532

Hoistable arm (with ISS system only)



PIANTANE, CORDONI E ACCESSORI

DELIMITATION COLUMNS & ACCESSORIES

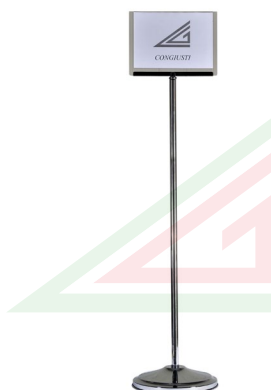

Piantana con cartello
A4 orizzontale
Column with horizontal A4 sign

Art. 0142

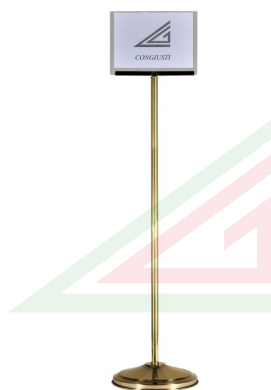

Piantana oro con cartello
A4 orizzontale
Golden column with horizontal A4 sign

Art. 0142/LUX

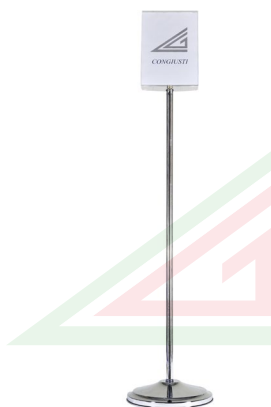

Piantana con cartello
A4 inclinato
Column with inclined A4 sign

Art. 0142/INCL

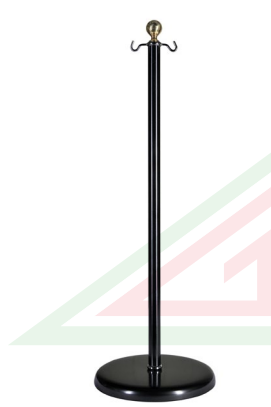

Piantana nera Ø 300 mm,
fusto Ø 30 mm
Ø 300 mm black column Ø 30 mm shaft

Art. 0601/298



Piantana cromata Ø 280 mm,
fusto Ø 30 mm
Ø 280 mm chromed column, Ø 30 mm shaft

Art. 0604/321



Piantana ottone cromato
Ø 300 mm, fusto Ø 30 mm
Ø 300 mm chrome brass column, Ø 30 mm shaft

Art. 0604/620

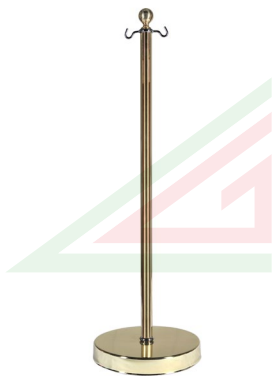

Piantana ottone Ø 280 mm,
fusto Ø 30 mm **Art. 0605/321**
Ø 280 mm golden brass column, Ø 30 mm shaft

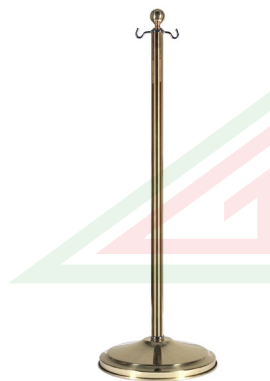

Piantana ottone Ø 300 mm,
fusto Ø 30 mm **Art. 0605/619**
Ø 300 mm golden brass column, Ø 30 mm shaft



Piantana nera Ø 300 mm,
fusto Ø 50 mm **Art. 0624/298**
Ø 300 mm black column, Ø 50 mm shaft

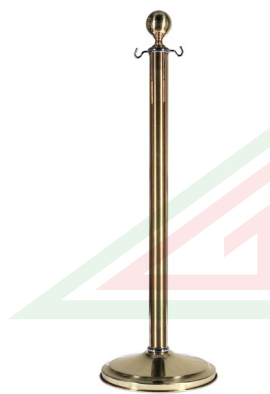

Piantana ottone Ø 300 mm,
fusto Ø 50 mm **Art. 0625/619**
Ø 300 mm golden brass column, Ø 50 mm shaft

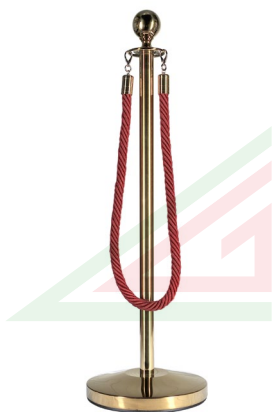

Piantana ottonata
economica **Art. 0950**
Economic brass plated column

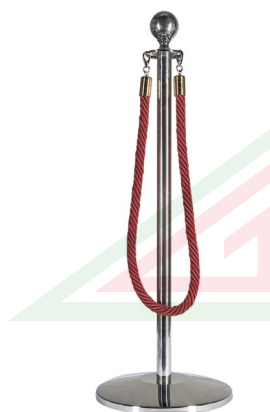

Piantana cromata
economica **Art. 0955**
Economic chromed column



Leggio plexiglass
 altezza 110 cm **Art. 0960**
Plexiglass list stand, 110 cm height

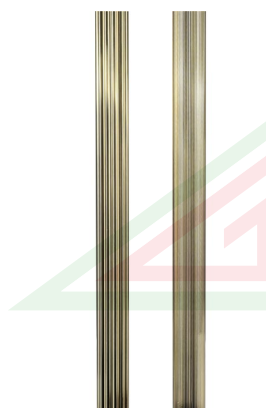

Opzione tubo rigato Ø 30 mm
 Ø 30 mm striped stand available



Cordone bordeaux
Brownish-red rope

Ø 20 mm **Art. 0615/20**
 Ø 25 mm **Art. 0615/25**
 Ø 30 mm **Art. 0615/30**



Cordone sintetico Ø 30 mm **Art. 0616**
 Ø 30 mm syntetic rope



Capicorda in ottone dorato
Golden brass rope terminal

Ø 20 mm **Art. 0614/20**
 Ø 25 mm **Art. 0614/25**
 Ø 30 mm **Art. 0614/30**



Capicorda in ottone cromato
Chrome brass rope terminal

Ø 20 mm **Art. 0614/20/C**
 Ø 25 mm **Art. 0614/25/C**
 Ø 30 mm **Art. 0614/30/C**





Capicorda in ottone con moschettone
Golden brass rope terminal with snap-hook

Ø 25 mm
Ø 30 mm

Art. 0971
Art. 0972

Versione in ottone cromato
Chrome brass version

Ø 25 mm
Ø 30 mm

Art. 0971/C
Art. 0972/C



Capicorda ottonato con
moschettone Ø 30 mm
*Ø 30 mm brass plated rope terminal with
snap hook*

Art. 0976

Versione cromata
Chromed version

Art. 0976/C



Gancio da parete ottonato
Brass plated wall hook

Art. 1113

Gancio da parete cromato
Chrome wall hook

Art. 1114

PIANTANE TENDEX E ACCESSORI

QUEUE BARRIERS AND ACCESSORIES



Versione cromata
Chromed version

Art. 0910



Versione nera
Black version

Art. 0920

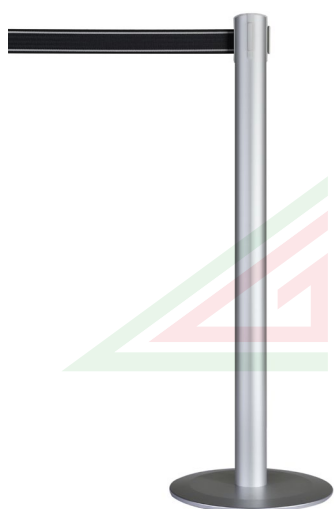

Versione alluminio
Satin aluminium version

Art. 0915



Versione economica
Economic version

Art. 0970

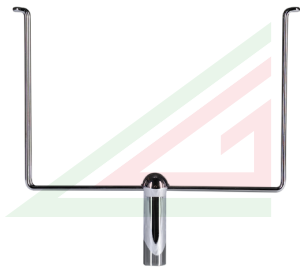

Supporto cromato
per plexiglass
Chromed plexiglass holder

Art. 0900



Supporto A4 economico
Economic plexiglass holder

Art. 0973



Tendex cromato da parete
Wall mount retractable system

Art. 1120



Anello cromato da parete
Wall mount chromed ring

Art. 1115

Clip per tendex da parete
Wall mount clip for retractable system

Art. 1121

ARTICOLI PER GAGLIARDETTI

PENNANTS ITEMS



Borchie ottone

Brass finials

Ø 7 mm, foro Ø 2 mm

Art. 0801

Ø 7 mm, Ø 2 mm hole

Ø 10 mm, foro Ø 3 mm

Art. 0803

Ø 10 mm, Ø 3 mm hole

Ø 12 mm, foro Ø 4 mm

Art. 0804

Ø 12 mm, Ø 4 mm hole

Traversini

Metal tie

Ø 2 mm fino a 15 cm

Art. 0805

Ø 2 mm up to 15 cm

Ø 2 mm fino a 25 cm

Art. 0807

Ø 2 mm up to 25 cm

Ø 2 mm L. 100 cm

Art. 0808

Ø 2 mm, 100 cm length

Ø 3 mm fino a 20 cm

Art. 0810

Ø 3 mm up to 20 cm

Ø 3 mm fino a 30 cm

Art. 0812

Ø 3 mm up to 30 cm

Ø 3 mm fino a 40 cm

Art. 0814

Ø 3 mm up to 40 cm

Ø 3 mm L. 100 cm

Art. 0815

Ø 3 mm, 100 cm length

Ø 4 mm fino a 40 cm

Art. 0816

Ø 4 mm up to 40 cm

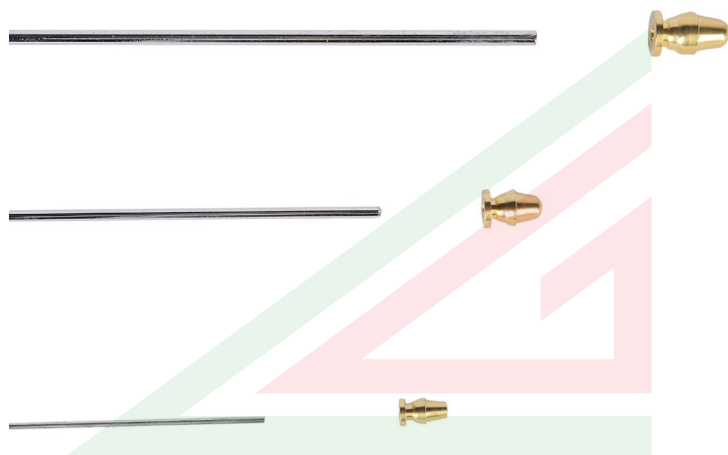

ARTICOLI PER VEICOLI

VEHICLES ITEMS

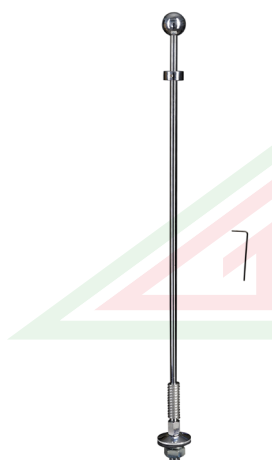

Asta cromata per auto e moto

Ø 6 mm x 35 cm

Art. 0007

Ø 6 mm x 35 cm chromed flagpole for car and motorcycle

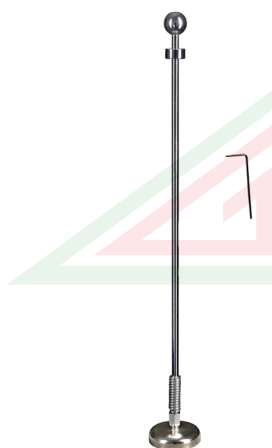

Attacco a magnete per Art. 0007

Art. 1205

Magnet for Art. 0007

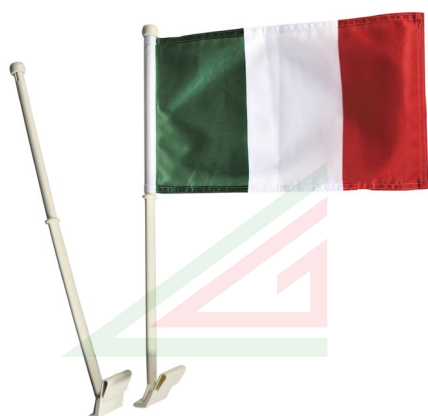

Supporto bandiera per finestrino

Art. 0975

Car window flagpole



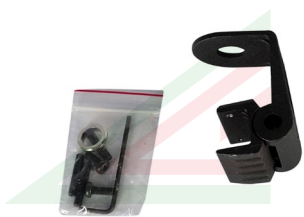

Attacco a gronda
Flagpole clip

Art. 1055

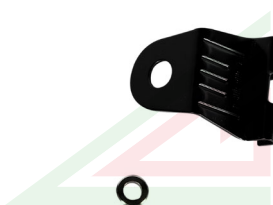

Attacco per baule
Trunk joint

Art. 1186



Asta Ø 6 mm, L. 1500 mm in fibra per bicicletta **Art. 0974**
Ø 6 mm, length 1500 mm fiberglass flagpole for bicycle

ACCESSORI E RICAMBI

ACCESSORIES AND REPLACEMENT PARTS

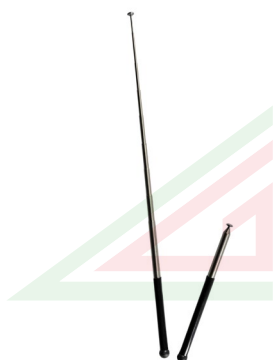

Asta telescopica per guide turistiche cm 20/140 **Art. 0010**
Telescopic pole for tour-guide

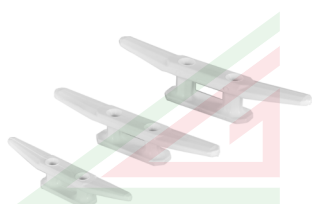

Bitte
Cleats

cm 11
cm 14,5
cm 17,5

Art. 0557
Art. 0558
Art. 0559



Sistema Open Flag
Open flag system

Art. 1200

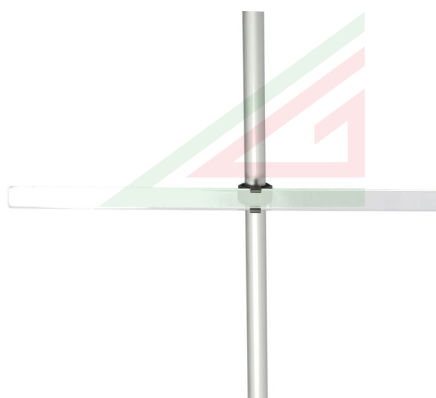

Telaio per baldacchino
Canopied structure

Art. TELAIO



Manicotti in ottone cromato di ricambio
Replacement chrome brass pipes

Per asta:
For pole:

Ø 22 mm	Art. 0350
Ø 25 mm	Art. 0304
Ø 32 mm	Art. 0351
Ø 35 mm	Art. 0352
Ø 37-42 mm	Art. 0353



Manicotti in ottone dorato di ricambio
Replacement golden brass pipes

Per asta:
For pole:

Ø 22 mm	Art. 0350/LUX
Ø 25 mm	Art. 0304/LUX
Ø 32 mm	Art. 0351/LUX
Ø 35 mm	Art. 0352/LUX
Ø 37-42 mm	Art. 0353/LUX



Riduzione ottone **Art. 1000**



Distanziale ottone dorato Ø 50 mm **Art. 1059**
Ø 50 mm golden brass spacer

Distanziale ottone cromato Ø 50 mm **Art. 1059/C**
Ø 50 mm chrome brass spacer



Distanziale ottone dorato Ø 70 mm **Art. 1060**
Ø 70 mm golden brass spacer

Distanziale ottone cromato Ø 70 mm **Art. 1060/C**
Ø 70 mm chrome brass spacer

CONDIZIONI GENERALI DI VENDITA

- 1) Le vendite effettuate dalla ns. Società sono regolate esclusivamente dalle presenti condizioni generali, salvo che vengano consensualmente derogate per iscritto.
- 2) Le ns. offerte o proposte di fornitura si intendono sempre senza impegno. I termini di consegna, eventualmente indicati tanto nelle offerte che nelle conferme d'ordine, non sono per noi impegnativi e l'evasione dell'ordine è subordinata alla disponibilità del materiale. Gli ordini devono pervenire mediante lettera o fax di commissione sottoscritti dal committente e salvo approvazione della ns. Società.
- 3) Nella fatturazione verranno applicati i prezzi vigenti al momento della consegna della merce; di conseguenza l'indicazione dei prezzi contenuta nei listini e nelle ordinazioni è puramente indicativa.
- 4) La merce viaggia sempre a rischio e pericolo del committente anche se la spedizione viene effettuata franco destino. In mancanza di precise istruzioni circa il mezzo di trasporto, la merce verrà spedita con il mezzo da noi ritenuto più opportuno.
- 5) Eventuali reclami sulla quantità e qualità della merce devono essere fatti mediante lettera raccomandata e devono pervenirci entro e non oltre 8 giorni dal ricevimento della merce, sotto pena di decadenza.
- 6) I ritorni di merce devono essere da noi autorizzati e comunque effettuati in porto franco.
- 7) Gli imballaggi vengono fatturati al prezzo di costo e non si accettano di ritorno.
- 8) I pagamenti dovranno essere fatti al domicilio del creditore. Qualunque sia il mezzo di pagamento convenuto, la parte venditrice non rinuncia all'art. 1498 u.c.C.C.I. I pagamenti dovranno essere comprensivi dell'I.V.A. se ed in quanto dovuta.
- 9) I termini convenuti di pagamento sono essenziali; ove non vengano dal committente rispettati, la parte venditrice ha diritto di richiedere gli interessi relativi.
- 10) Il mancato rispetto dei termini di pagamento convenuti fa decadere l'acquirente dal beneficio del pagamento dilazionato e annulla eventuali ordini non evasi.
- 11) Qualsiasi controversia non potrà costituire causa di ritardo o sospensione dei pagamenti.
- 12) Poiché i contratti si intendono convenzionalmente conclusi a Brescia resta ferma la competenza esclusiva dell'Autorità Giudiziaria di Brescia per qualsiasi controversia nascente dal presente rapporto.

La ns. Società si riserva il diritto di variare le caratteristiche estetiche e tecniche degli articoli esposti nel presente catalogo.



F.lli CONGIUSTI

COME TROVARCI

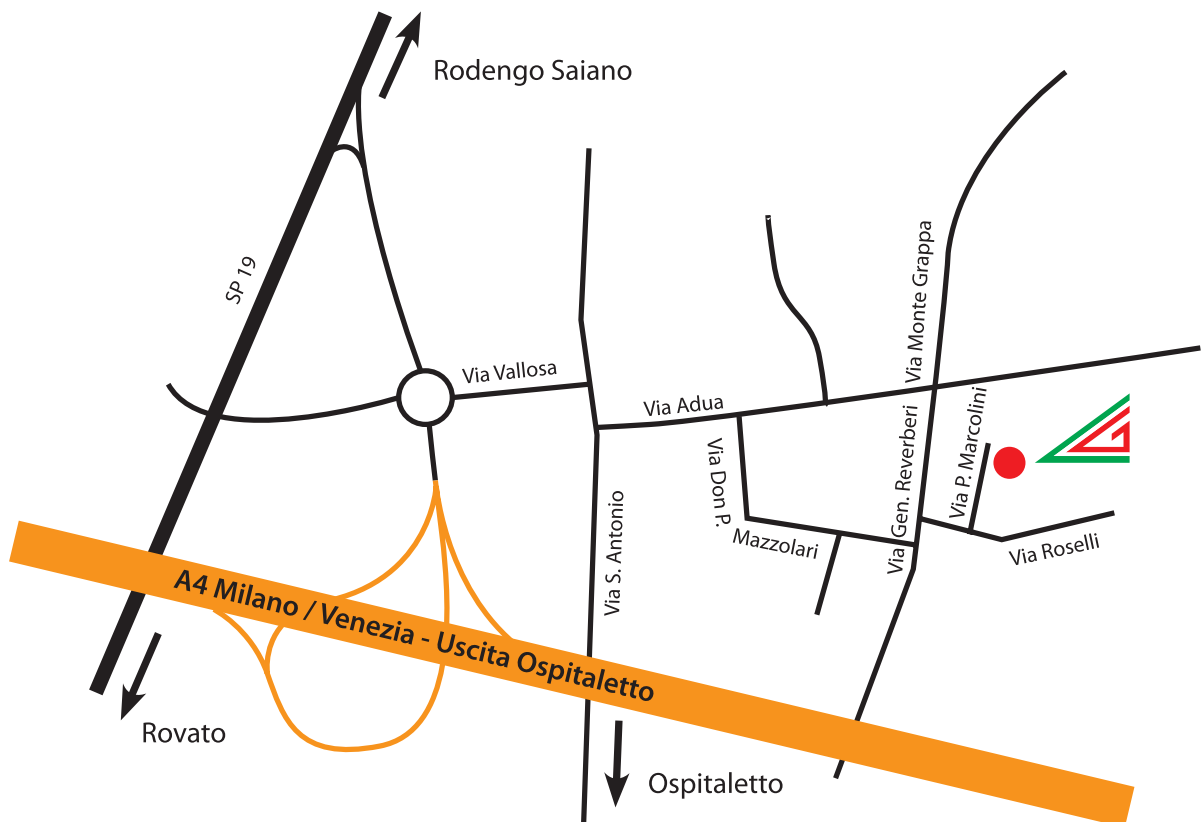



F.lli CONGIUSTI

25050 Passirano (BS) - Italia
Via Padre Marcolini, 2/a
Tel. +39 030.6857603 - Fax +39 030.6857604
E-mail: info@congiusti.it
www.congiusti.it